

# Dry anaerobic digestion of organic residues on-farm - a feasibility study

Winfried Schäfer, Marja Lehto and Frederick Teye

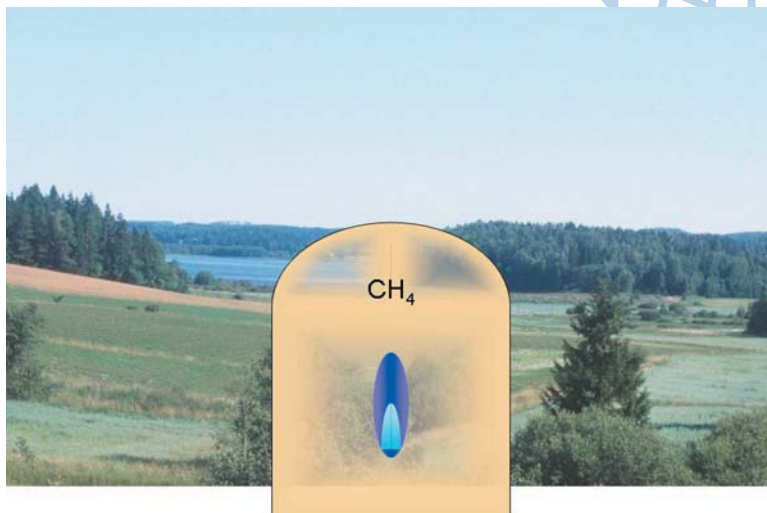

Agricultural engineering

Agrifood Research Reports 77  
98 s.

**Dry anaerobic digestion of  
organic residues on-farm  
- a feasibility study**

Winfried Schäfer, Marja Lehto and Frederick Teye

ISBN 952-487-006-1 (Printed version)  
ISBN 952-487-007-X (Electronic version)  
ISSN 1458-5073 (Printed version)  
ISSN 1458-5081 (Electronic version)  
[www.mtt.fi/met/pdf/met77.pdf](http://www.mtt.fi/met/pdf/met77.pdf)

Copyright

MTT Agrifood Research Finland  
Winfried Schäfer, Marja Lehto, Frederick Teye  
Publisher

MTT Agrifood Research Finland

Distribution and sale

MTT Agrifood Research Finland, Animal Production Research

Vakolantie 55, FI-03400 Vihti, Finland

Phone +358 9 224 251, Fax +358 9 224 6210

e-mail: [julkaisut@mtt.fi](mailto:julkaisut@mtt.fi)

Printing year

2006

Photographer

Winfried Schäfer

Printing house

Strålfors Information Logistics Oy

# Dry anaerobic digestion of organic residues on-farm - a feasibility study

Winfried Schäfer<sup>1)</sup>, Marja Lehto<sup>1)</sup>, Frederick Teye<sup>2)</sup>

<sup>1)</sup>MTT Agrifood Research Finland, Animal Production Research, Vakolantie 55, FI-03400 Vihti, Finland, [winfried.schafer@mtt.fi](mailto:winfried.schafer@mtt.fi), [marja.lehto@mtt.fi](mailto:marja.lehto@mtt.fi)

<sup>2)</sup>MTT Agrifood Research Finland, Plant Production Research, Vakolantie 55, FI-03400 Vihti, Finland, [frederick.teye@mtt.fi](mailto:frederick.teye@mtt.fi), Present contact: [kwame@mappi.helsinki.fi](mailto:kwame@mappi.helsinki.fi)

## Abstract

### Objectives

The feasibility study shall answer the following questions: Are there economical and ecological advantages of on-farm dry digestion biogas plants? How does the construction and operation parameters of a dry digestion biogas plant influence environment, profit, and sustainability of on-farm biogas production?

The aim of the feasibility study is to provide facts and figures for decision makers in Finland to support the development of the economically and environmentally most promising biogas technology on-farm. The results may encourage on-farm biogas plant manufacturers to develop and market dry anaerobic digestion technology as a complementary technology. This technology may be a competitive alternative for farms using a dry manure chain or even for stockless farms.

### Results

Up to now farm scale dry digestion technology does not offer competitive advantages in biogas production compared to slurry based technology as far as only energy production is concerned. However, the results give an overview of existing technical solutions of farm-scale dry digestion plants. The results also show that the ideal technical solution is not invented yet. This may be a challenge for farmers and entrepreneurs interested in planning and developing future dry digestion biogas plants on-farm. The development of new dry digestion prototype plants requires appropriate compensation for environmental benefits like closed energy and nutrient cycles to improve the economy of biogas production. The prototype in Järna meets the objectives of the project since beside energy a new compost product from the solid fraction was generated. On the other hand the two-phase process consumes much energy and the investment costs are high (>2000 € m<sup>-3</sup> reactor volume).

Dry digestion on-farm offers the following advantages: Good process stability and reliability, no problems like foam or sedimentation, cheap modules for batch reactors, less reactor capacity, reduced transport costs due to re-

duced mass transfer with respect of the produced biogas quantity per mass unit, compost of solid digestion residues suitable as fertiliser also outside the farm gate, use of on-farm available technology for filling and discharging the reactor, less process energy for heating because of reduced reactor size, no process energy for stirring, reduced odour emissions, reduced nutrient run off during storage and distribution of residues because there is no liquid mass transfer, suitable for farms using deep litter systems.

These advantages are compensated by following constraints: Up to 50% of digestion residues are needed as inoculation material (cattle manure does not need inoculation) requiring more reactor capacity and mixing facilities. Retention time of dry digestion is up to three times longer compared to wet digestion requiring more reactor capacity and more process energy, filling and discharging batch reactors is time and energy consuming. We conclude that only farm specific conditions may be in favour for dry digestion technology.

Generally, four factors decide about the economy of biogas production on-farm: Income from waste disposal services, compensation for reduction of greenhouse gas emission, compensation for energy production and - most important for sustainable agriculture - nutrient recycling benefits.

#### Evaluation of the results

We did not find any refereed scientific paper that includes a documentation of an on-farm dry digestion biogas plant. It seems that we tried first. We also could not find any results about the biogas potential of oat husks, so we may have found these results first.

Farm scale production of anaerobically treated solid manure for composting is new. Dry fermentation biogas plants offer the possibility to design solid manure compost by variation of fermentation process parameters.

From different scientific publication databases we found about 10 000 references concerning biogas research during the past 10 years. Less than ten are dealing with biogas reactors for non-liquid substrates on-farm. Recent research mainly concentrates on basic research, biogas process research for communal waste, large-scale biogas plants, and research on laboratory level. This mirrors the fact, that production of research papers is rather financed than product development on site. Our conclusion is that it seems worldwide to be very difficult or even impossible to find financial support for on site research, especially for on-farm prototype biogas reactors. We suppose the following reasons for this fact: biogas plant research requires proficiency in many different scientific disciplines, lack of co-operation between engineering and life sciences, high development costs to transfer basic research results into practical technical solutions, low interest of researchers because on site and on-farm research enjoys low appreciation in terms of scientific credits,

portability of farm specific design and process solutions is difficult. Our conclusion is that on site and on-farm research has to be supported by funding agencies if integration of biogas and bio energy into the farm organism is considered as an important target within the agricultural policy framework.

Future research on both dry fermentation technique and biogas yield of solid organic residues may close present knowledge gaps. Prototype research may offer competitive alternatives to wet fermentation for farms using a solid manure chain and/or energy crops for biogas production.

To encourage farmers and entrepreneurs to foster the development of dry fermentation technology support in terms of education and advisory services is also necessary.

---

*Key words: Biogas, anaerobic digestion, dry fermentation, on-farm*

---

# Kuivämädätys maatalan jätteiden käsittelyssä

Winfried Schäfer<sup>1)</sup>, Marja Lehto<sup>1)</sup>, Frederick Teye<sup>2)</sup>

<sup>1)</sup>MTT Kotieläintuotannon tutkimus, Vakolantie 55, 03400 Vihti, [winfried.schafer@mtt.fi](mailto:winfried.schafer@mtt.fi), [marja.lehto@mtt.fi](mailto:marja.lehto@mtt.fi)

<sup>2)</sup>MTT Kasvintuotannon tutkimus, Vakolantie 55, 03400 Vihti, [frederick.teye@mtt.fi](mailto:frederick.teye@mtt.fi), nykyinen sähköpostiosoite: [kwame@mappi.helsinki.fi](mailto:kwame@mappi.helsinki.fi)

## Tiivistelmä

Tavoitteet:

Tutkimuksen tavoitteena oli selvittää kuivämädätyslaitoksen rakenne- ja toimintaparametrien vaikutusta biokaasutuotannon kannattavuuteen, kestävyys- ja ympäristökysymyksiin tilatasolla sekä sitä, voidaanko tilatason kuivämädätyslaitoksesta saada taloudellista ja ekologista hyötyä.

Toisena tavoitteena oli hankkia yksityiskohtaista tietoa suomalaisille päätöksentekijöille, jotta sekä taloudellisesti että ympäristön kannalta lupaavimpien tilatason biokaasuteknologioiden kehitystä voitaisiin edistää. Tulokset rohkaisevat tilatason biokaasulaitosten valmistajia kehittämään ja myymään kuivämädätysteknologiaa vaihtoehtoisena teknologiana. Tämä teknologia voisi olla kilpailukykyinen vaihtoehto tiloille, joilla käytetään kuivalantakettia tai vaikka karjattomille tiloille.

Tulokset:

Kuivämädätysteknologia maatalatasolla ei ole pystynyt tähän asti tarjoamaan kilpailukykyistä vaihtoehtoa lietteen mädätykseen perustuvalla teknologialla, jos tarkastelun kohteena on pelkkä energian tuotanto. Hankkeen tuloksena saatiin yleiskuva tiloilla toimivien kuivämädätyslaitosten mielenkiintoisista teknologisista ratkaisuista. Voidaan myös todeta, että parhaita ratkaisuja ei ole vielä keksitty. Tämä voisi olla haaste viljelijöille ja elinkeinonharjoittajille, jotka ovat kiinnostuneita kehittämään ja suunnittelemaan tulevaisuuden tilatason kuivämädätyslaitosta. Uuden kuivämädätyslaitoksen prototyypin kehittäminen vaatii ympäristöhyötyjen (esim. suljettu energia- ja ravinnekierto) rahallista korvausta, mikä myös parantaisi biokaasutuotannon kannattavuutta. Järman prototyyppi täytti hankkeen tavoitteet, sillä energian lisäksi saatiin uusi kompostituote kiinteästä jakeesta. Toisaalta kaksivaiheinen mädätysprosessi kuluttaa paljon energiaa ja investointikustannukset ovat korkeat (>2000 € m<sup>-3</sup> reaktoritilavuutta).

Tilatason kuivämädätyksellä on useita etuja: Prosessi on vakaa ja luotettava, ei tapahdu vaahtoamista tai saostumista ja panosreaktorin rakenteet ovat edullisia. Etuja, verrattuna lietereaktoreihin, ovat reaktorin pienempi tilavuus

ja pienemmät kuljetuskustannukset vähentyneen massan siirron vuoksi suhteessa tuotettuun biokaasumäärään massayksikköä kohti. Etu on myös maatilalla olemassa olevan teknologian hyväksikäyttö massan syöttö- ja poistovaiheessa. Etuina voidaan mainita myös, että prosessin lämmitysenergian tarve on pienempi, koska reaktorin tilavuus on pienempi ja sekoitusta ei tarvita, hajupäästöt vähenevät ja ravinnehäviöt ovat pienemmät varastoinnissa ja lopputuotteen levityksessä, koska nestemäistä jaetta ei siirretä. Kompostoitua kiinteää jaetta voidaan markkinoida lannoitteena myös tilan ulkopuolelle. Laitos soveltuu maatilalle, jossa käytetään kuivikepohjia.

Menetelmällä on myös rajoituksia: Jopa 50% mädätysjäännöksestä tarvitaan ympypäsmateriaaliksi (nautakarjan lanta ei vaadi ympypäystä) ja tähän tarvitaan enemmän reaktoritilavuutta ja sekoitusvälineitä. Kuivamädätyksen viipymäaika on jopa kolme kertaa pidempi verrattuna lietteen mädätykseen, vaatien enemmän reaktoritilavuutta ja prosessienergiaa. Panosreaktorin syöttö ja tyhjentäminen ovat aikaa ja energiaa vaativia vaiheita. Voidaan päätellä, että vain tilakohtaiset olosuhteet voivat suosia kuivamädätysteknologiaa.

Tilatasolla tapahtuvan biokaasutuotannon talouteen vaikuttavat neljä tekijää: Jätteenkäsittelystä saadut tulot, kasvihuonekaasupäästöjen vähentämisestä saatu korvaus, korvaus energian tuotannosta ja - kestäväälle maataloudelle tärkein - ravinteiden kierrosta saatu hyöty.

Tulosten tarkastelu:

Yhtään asiantuntijatarkastettua tieteellistä artikkelia, jossa olisi dokumentoitu tilatason kuivamädätyslaitosta, ei löytynyt. Näyttää siltä, että me yritimme ensimmäisinä. Myöskään tuloksia kaura-akanoiden biokaasupotentiaalista ei ole aikaisemmin julkaistu.

Uutta on myös tilatason anaerobisesta käsittelystä saadun kiinteän jakeen kompostointi. Kuivamädätyslaitos tarjoaa mahdollisuuden erilaisten kuivantalantakompostien tuottamiseen mädätysprosessiparametreja muuttamalla.

Tieteellisistä julkaisutietokannoista löytyi noin 10 000 viitettä, jotka käsitelivät biokaasututkimusta viimeisen 10 vuoden ajalta. Näistä alle 10 käsitteli biokaasureaktoreita, jotka oli kehitetty ei-nestemäisten lähtöaineiden käsitteilyyn maatilalla. Viimeisin tutkimus keskittyy pääasiassa perustutkimukseen, yhdyskuntajätteen biokaasuprosessien tutkimukseen, suuren mittakaavan biokaasulaitoksiin sekä laboratoriomittakaavan tutkimukseen. Tämä kuvastaa sitä tosiasiaa, että julkaisujen tuottaminen on tärkeämpää kuin tilatason tutkimus ja tuotekehitys. Maailmanlaajuisesti näyttää siltä, että on erittäin vaikeaa, ellei mahdotonta, löytää rahoittajaa tilatason tutkimukselle, erityisesti tilatason biokaasureaktorin prototyypitutkimukselle. Syyt tähän voivat olla seuraavat: Biokaasulaitoksia käsittelevä tutkimus vaatii monien tieteenalojen osaamista, yhteistyön puute insinöörien ja biotieteilijöiden välillä, korkeat



kustannukset perustutkimustulosten siirtämisestä käytännön tekniisiin sovelluksiin, tutkijoiden vähäinen kiinnostus, koska tilalla tehtävällä tutkimuksella on alhainen arvostus tieteellisellä arvoasteikolla ja tilakohtaisten rakenne- ja prosessiratkaisujen rajalliset siirtomahdollisuudet. Rahoittajien pitäisi tukea paikka- tai tilakohtaista tutkimusta, jos bioenergia- ja biokaasuteknologian liittämistä maatalan rakenteisiin pidetään tärkeänä tavoitteena maatalouspoliittisessa viitekehyksessä.

Sekä kuivamädätyksen tekniikkaa että kiinteiden orgaanisten jätteiden biokaasutuottopotentiaalia on tulevaisuudessa tutkittava, jotta tällä hetkellä olemassa oleva tietovaje voidaan korvata. Kuivamädätyslaitosten prototyypit tutkimus voi tarjota kilpailukykyisen vaihtoehdon lietteen mädätykselle niillä tiloilla, jotka käyttävät kuivalantaketjua ja/tai energiakasveja biokaasun tuotantoon.

On myös välttämätöntä rohkaista viljelijöitä ja elinkeinonharjoittajia kuivamädätysteknologian kehittämiseen koulutusta ja neuvontapalveluja lisäämällä.

---

*Asiasanat: Biokaasu, kuivalanta, mädätys, jatkuvatoiminen prosessi, maatalo-*

---

## Foreword

Finnish agriculture experienced rapid changes after Finland joined the EU. Decreasing producer prices, increasing factor costs, increasing pollution of lakes and the Baltic Sea by blue algae mainly caused by nutrients run off from chemical fertilisers combined with a tragic drain of people and resources from country side to metropolitan areas force decision makers to find agricultural policy measures to ensure future income of the farmers left over.

After the Second World War, industrialisation of agricultural production and subsidies for the Finnish agriculture resolved successfully the foodstuff demand of increasing population but led finally to overproduction and environmental pollution. Now it seems that another fashion follows the green revolution: bio-energy production on-farm shall save the imminent collapse of rural areas. On-farm biomass production shall reduce CO<sub>2</sub> emissions and simultaneously secure the farmers income since the fossil energy resources are soon exploited.

Independent top scientists showed for decades that the energy balance of fuel production like ethanol or bio-diesel from field crops is negative, not sustainable, and very expensive. However, many decision makers support fuel production from energy crops to satisfy the farmers associations, the ethanol and bio-diesel industry, and the public although sustainability is hardly achieved in contrast to fuel and biogas production from organic residues and organic waste.

In Europe, the German speaking countries and Denmark support the production of biogas on-farm. The positive effect is, that organic farm residues and organic waste is recycled and by this the nutrient and energy balance of the farm is improved. The negative impact is the increasing use of maize for large-scale biogas production produced by the help of agricultural subsidies.

The idea to reduce nutrient run off to the Baltic Sea and to recycle residues and waste from agricultural production, local food processing, and consumers by use of a biogas plant on-farm was the starting point of planning the biogas plant design in Järna. In spite of economical constraints due to the prevailing energy prices, the plant was constructed. A visit in autumn 2003 gave me the inspiration to focus on anaerobic digestion of solid organic material. I thank Prof. Artur Granstedt and Lars Evers for excellent co-operation within our joint project.

Vihti 31.3.2006

Winfried Schäfer

# Contents

1	Introduction.....	11
1.1	Dry anaerobic digestion plants on-farm .....	12
1.2	Environmental impact of dry anaerobic digestion.....	17
1.3	Use of digestion residues.....	18
1.4	Economic assessment in respect of Finnish farms. ....	19
2	Material and methods.....	20
2.1	Technical documentation.....	21
2.2	Sampling and analysis of organic matter.....	22
2.3	Composting experiments.....	22
2.4	Modelling material, nutrient and energy flow.....	23
2.4.1	Mass balance .....	23
2.4.2	Nutrient balance .....	27
2.4.3	Energy balance .....	28
2.5	Cost benefit analysis.....	30
3	Results.....	33
3.1	Technical documentation of the biogas plant in Järna .....	33
3.1.1	Design and material flow .....	34
3.1.2	Mass balance .....	38
3.1.3	Nutrient balance .....	43
3.1.4	Energy balance .....	45
3.2	Assessment of decontamination .....	46
3.3	Economic assessment.....	48
3.4	Environmental assessment.....	49
4	Discussion .....	52
4.1	Conclusions for farmers .....	52
4.2	Conclusions for biogas plant manufacturers .....	53
4.3	Conclusions for decision makers.....	54
5	Summary .....	57
6	References .....	58
7	Appendices.....	65

# 1 Introduction

European countries are committed to reduce CO<sub>2</sub> emission originating from fossil fuels. Additionally changes in policy priorities as well as the development of agricultural technology are important driving forces. The past subsidy policy urged farmers for mass production where yield maximisation and profit maximisation correlated closely. Now farmers are pushed to replace quantity by quality. The new challenge for pioneer farmers is therefore sustainable landscape management. This includes orienting farmers towards entrepreneurship and markets and responding to consumers and citizen's expectations to safeguard in the long-term integrity of farm support (European Commission 2003). Both objectives sustainable landscape management and market-oriented farming coincide with the basic organic farming principles (IFOAM 2002). Organic farming principles for their parts include the use of renewable energy resources and minimising nutrient losses on-farm as far as possible. On-farm produced biogas may replace energy produced from fossil fuels and so contribute to achieve the target to reduce green house gas emissions. Dry anaerobic digestion of organic material reduces losses of nitrogen.

Organic wastes are subject of environmental legislation and dumping is no more allowed from beginning of the year 2005 (VNp 861/1997). They are ideal co-substrates for biogas plants and support nutrient recycling on-farm. Animal-based organic waste is also suitable for biogas production. In accordance with the EU-regulation (EU 1774/2002), animal by-products can be used for biogas production too. Anaerobic dry batch fermentation reduces pathogen agents originating from humans, animals, and plants up to 99.9% (Look et al. 1999, Brummeler 2000). In remote areas, transport of animal-based organic waste may easily increase transport costs unreasonably. Anaerobic fermentation on-farm will relieve this burden.

Mainstream farm areas with intensive animal production like fur or poultry farms do not have enough farmland to dispose the manure according to the nitrate directive (VNa 931/2000). Especially fast growing animal production units need alternatives to usual manure and slurry treatment technology (Lehtimäki 1995). Anaerobic fermentation may be a suitable technique to solve these problems.

The most on-farm biogas plants in Europe use slurry and co-substrate. However, this technology is reasonable only on farms using already slurry technique. Slurry biogas plants are well developed in those European countries, where investment subsidies for biogas plants are granted in combination with high compensation for electric power production. These conditions prevail mainly in German speaking countries, figure 1.

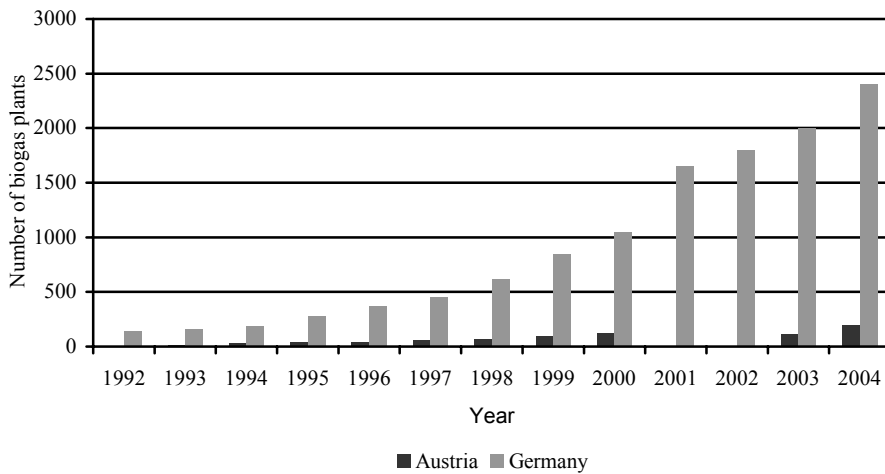

Figure 1. Number of biogas plants in Austria and Germany (Braun et al. 2005, Boxberger et al. 2002, Weiland & Rieger 2005).

## 1.1 Dry anaerobic digestion plants on-farm

Present commercially available biogas plants are mainly suitable for slurry and co-substrates. Cattle, horse, and poultry farms using a solid manure chain experience a crucial competitive disadvantage, because both feeding equipment of solid organic material to slurry reactors and conversion to slurry technology for spreading fermentation residues requires additional investments.

In contrast to on-farm biogas plants the capacity of European dry anaerobic fermentation biogas plants used in municipal organic waste disposal exceeds the capacity of wet fermentation plants, 57 Mg/a versus 48 Mg/a (Kraft 2004). Numerous manufactures offer special process technologies. The process description is available from the enterprises: 3A <http://www.3a-biogas.com/>, ATF (Fischer et al. 1994), BEKON <http://www.bekon-energy.de/>, KOMPO-GAS <http://www.kompogas.ch/>, DRANCO [www.ows.be](http://www.ows.be), VALORGA <http://www.valorgainternational.fr/>. Table 1 presents typical parameters of municipal solid waste plants.

Table 1. Technical parameters of common large-scale organic waste disposal dry fermentation plants (Kraft 2004).

Process	Waste	Capacity	TS within fermenter	Retention	Biogas yield			Volume content
		Mg a <sup>-1</sup>	%		d	Nm <sup>3</sup> Mg <sup>-1</sup> VS	Nm <sup>3</sup> Mg <sup>-1</sup> VS	Nm <sup>3</sup> Mg <sup>-1</sup> Input
3A	Bio waste			45-50	410	285	100	55
BEKON	Bio waste		≤50	28-35	240-530	170-370	60-130	55-60
KOMPO-GAS	Bio waste, green cut	20000	35	15-20	380	245	85	50-63
ATF	Bio waste	1000	35-50	15-25	120-400	96-320	30-96	55-65
DRANCO	Bio waste	20000	18-26	20-30	550-780	390-550	120-170	50-65
DRANCO	Residues	13500	56	25	460-490	240-250	133-144	55
VALORGA	Bio waste	52000	30-35	24	390-410	175-185	80-85	55-60

An early prototype plant for digestion of solid organic farm residues was developed in the Netherlands 1980-1984 (Hofenk et al. 1984) but it was not considered competitive with dumping. Based on the technological progress of anaerobic digestion of municipal solid waste, farm scale dry fermentation prototype plants were developed for anaerobic digestion of organic material containing 15 to 50% total solids (Hoffman 2001). The reported top ten benefits of dry anaerobic digestion biogas plants (Hoffmann & Lutz 2000, Hoffmann 2000) are obviously in line with the objectives of organic farming principles and strengthen sustainable agriculture:

1. Dry anaerobic digestion is suitable for nearly all farm residues like manure, plant residues, and household organic wastes. Higher energy density compared to slurry digestion requires less capacity of the reactor and reduces construction costs.
2. High dry matter content reduces transport costs due to reduced mass transfer in respect of the produced biogas quantity per mass unit.
3. Mobile digester modules allow batch production and continuous, well controllable gas production.

4. Dry anaerobic digestion residues are suitable for composting and by this useful fertilisers outside the farm gate e.g. estate gardeners.
5. Dry anaerobic batch digestion does not need special techniques like slurry pumps, mixers, shredders, and liquid manure injectors for distribution. Most machinery necessary for filling and discharging the digester like front loader and manure spreader is often already available on-farm.
6. Process energy demand for heating is lower than in slurry reactors because of reduced reactor size. Process energy of dry anaerobic batch digestion is not required because there is no need of continuous homogenisation.
7. Improved process stability and reliability. There occur no problems like foam or sedimentation. Possible digestion breakdowns are easily to resolve in batch digesters by exchanging the module.
8. Reduced odour emissions because there is no slurry involved. According to Benthem & Hänninen (2001), anaerobic digestion reduces odours from slurry and kitchen waste up to 80%.
9. Reduced nutrient run off during storage and distribution of digester residues because there is no liquid mass transfer.
10. Suitable for farms without slurry technology, especially farms using deep litter systems e.g. chicken production. We estimate that 60% of Finnish manure originates from farms handling solid manure.

On-farm research (Gronauer & Aschmann 2004, Kusch & Oechsner, 2004, Kusch et al. 2005) and prototype research (Linke et al. 2002, Linke 2004) on dry fermentation in batch reactors show that loading and discharging of batch reactors remains difficult and/or time-consuming compared to slurry reactors. Additionally a constant level of gas generation requires offset operation of several batch reactors. Baserga et al. (1994) developed a pilot plant of 9.6 m<sup>3</sup> capacity for continuous digestion of solid beef cattle manure on-farm. However, on-farm dry fermentation plants are not common and rarely commercially available. We assume that lack of tested technical solutions and scarceness of on-farm research results are the main reason for low acceptance of dry fermentation technology on-farm.

Table 2 and table 3 show a summary of farm scale dry fermentation plants developed up to now. By our knowledge, only the batch module reactor is commercially available all others are either farm scale prototypes or research reactors.

Table 2. On-farm dry fermentation batch reactors.

- Concrete or steel container	Kuusinen & Valo (1987) tested the first Finnish prototype at the Labby-farm in Isnäs. The capacity was 100 m <sup>3</sup> ; the organic material was a mixture of pig manure and straw from turnip rape and wheat. It was not competitive.
- Container module	<p>Hoffmann (2000) described a module system using lorry platforms and steel containers. The low cost of the reactor module is partly compensated by the large quantity of inoculum (up to 60%) required.</p> <p>Gronauer &amp; Aschmann (2004) evaluated a two-container plant of 112 m<sup>3</sup> capacity using grass silage, dairy, and poultry manure and residues from landscape green cuttings. This type is the only commercially available one.</p> <p>Kusch et al. (2005) described a similar prototype made of 4 containers à 128.7 m<sup>3</sup> capacity set up by a farmer.</p>
- Plastic bag	Linke et al. (2002) tested and Jäkel (2004) evaluated the use of the US AG-BAG silage-technology. A plastic bag of about 250 m <sup>3</sup> capacity serves as biogas reactor. Up to now, there are promising and disappointing results, the latter ones during wintertime.
- Dome reactor	A cheap wire mesh cage as reactor cover was developed at Leibniz-Institute of Agricultural Engineering Bornim (ATB) and evaluated by Mumme (2003) with promising results. The capacity of the reactor was 7.5 m <sup>3</sup> and the reactor digested manure and grass silage.
- Foil cover	A foil covered heap reactor of 20 m <sup>3</sup> capacity was developed at ATB and described by Schulze (2005). In contrast to the container module only 0.2% inoculum was necessary. This solution may be very suitable in tropical countries.
- Landfill-type cell	Parker (2000) described a similar foil cover plant: "In Texas two 91 m <sup>3</sup> cells were excavated in the native soil and lined on the top and bottom with EPDM geomembranes, and manure (32% VS) was placed within the cells. The biogas production appears to be highly temperature dependent, as biogas was produced for only 7 weeks out of the year." This solution may be suitable in tropical countries too.



Table 3. Continuously working on-farm dry fermentation reactors.

- Anacom	The first continuously working pilot reactor was set up at the Swiss agricultural engineering research institute (FAT) in Tänikon. Baserga et al. (1994) described and evaluated by the plant. The capacity was 9.6 m <sup>3</sup> . The reactor digested cattle manure and grass silage. It did not find its way into praxis.
- Fermentation channel	Also at FAT, a channel pilot reactor was developed and described by Baserga & Egger (1994). Baskets filled with solid manure pass through a slurry filled airtight fermentation channel. This solution did not find its way into praxis yet.

The performance parameters of dry fermentation reactors in figure 2 base on the findings from literature. The methane production refers to the volatile solids of the organic input and the reactor productivity to the reactor volume.

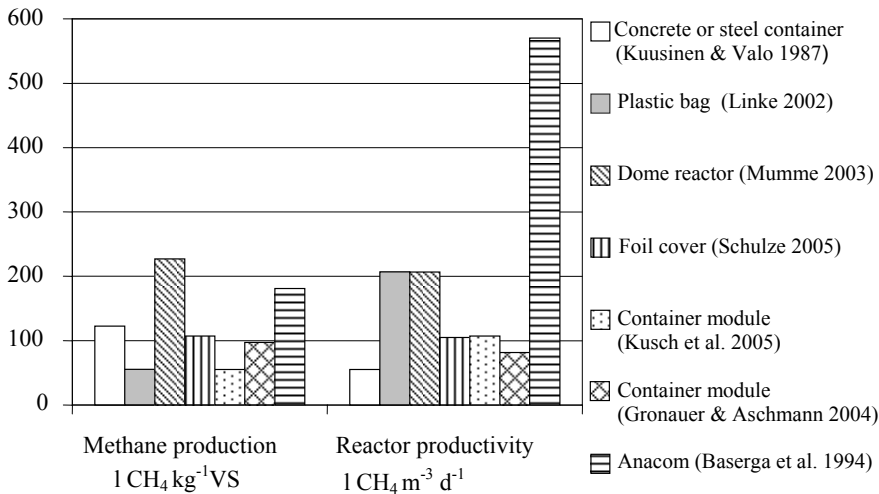

Figure 2. Comparison of methane production and reactor productivity.

There are many advantages compared to wet fermentation as shown in table 2 and 3 but most of them are compensated by disadvantages mainly caused by filling, emptying and mixing the organic material.

## 1.2 Environmental impact of dry anaerobic digestion

Reeh & Møller (2001) reported that the assessment of energy balance, nutrient recycling, and global warming came out in favour of biogas production, but especially the results regarding estimation of global warming mitigation differ according to the assumptions made. Their calculations showed that a fugitive loss of approx. 14% (biogas losses in Europe: 3.5 to 8.4%) of the biogas produced by anaerobic digestion will turn the scale in favour of composting regarding global warming mitigation. Regarding emission of xenobiotic compounds, they conclude that composting is much in favour because a number of organic micro-pollutants are rapidly degraded during composting as opposed to anaerobic treatment.

Schauss et al. (2005) focused on the emissions of anaerobically treated organic matter. Straw and intercrops were harvested, fermented in a biogas reactor, and applied as fertiliser on the field. Both, liquid and solid digestion residues were applied as fertiliser. Winter wheat generally revealed a low level of N<sub>2</sub>O emissions and indicated reduced losses (458 g N ha<sup>-1</sup> a<sup>-1</sup>) of the soil compared to the control variant (770 g N ha<sup>-1</sup> a<sup>-1</sup>). Measurements of the CH<sub>4</sub> fluxes showed a slightly decreased CH<sub>4</sub> uptake rate (484 g C ha<sup>-1</sup> a<sup>-1</sup>) compared to the control variant (591 g C ha<sup>-1</sup> a<sup>-1</sup>).

Stored solid manure heaps are a source of nitrous oxide and methane emissions (Yamulki 2006). In addition, indoor organic farmyard manure generates methane and nitrous oxide emissions. Sneath et al. (2006) measured a CH<sub>4</sub> emission rate of 17.1 g C m<sup>-3</sup> d<sup>-1</sup> and 411 mg N m<sup>-3</sup> d<sup>-1</sup>. Skiba et al. (2006) measured an emission rate of 1.4 – 38.6 g N<sub>2</sub>O-N m<sup>-3</sup> d<sup>-1</sup> for a 300 m<sup>3</sup> dung heap. Continuous anaerobic digestion of daily produced solid manure would reduce these losses. This is important because solid manure storage may cause even higher green house gas emissions than storage of slurry. EEA (2004) reported 0.3 to 0.6 kg TAN kg<sup>-1</sup> N for farmyard manure and 0.069 to 0.15 TAN kg<sup>-1</sup> N for slurry. Because the dry matter content of dry fermentation residues is high, it can be aerobically composted further.

Table 4. IPCC default emission factors for N<sub>2</sub>O emissions from manure management (EEA 2004).

Animal Waste Management System	Emission Factor <i>EF</i> <sub>3</sub> (AWMS) (kg N <sub>2</sub> O-N per kg N excreted) <sup>1</sup>
Liquid system	0.001 (< 0.001)
Solid storage & drylot	0.02 (0.005 - 0.03)

<sup>1</sup>see IPCC/OECD/IEA (1997) for default method to estimate N excretion per Animal Waste Management System

There may be other positive environmental impacts of dry anaerobic digestion biogas plants on farm compared to slurry biogas plants. If an aerobic process heats the solid organic matter followed by anaerobic fermentation two positive effects are achieved: First, the high temperature during the aerobic process reduces pathogens and second the generated heat is used as process heat for the following anaerobic process.

The anaerobic co-fermentation of organic municipal solid waste increases the biogas yield and contributes simultaneously to reduction of CO<sub>2</sub> emissions (Wulf et al. 2005). Möller (2003) estimates that aerobic composting of farmyard manure recycles 36.4 kg N ha<sup>-1</sup> (losses 35%), anaerobic digestion of farmyard manure 47 kg N ha<sup>-1</sup> (losses 16%), anaerobic digestion of farm yard manure and organic residues of the farm 76.4 kg N ha<sup>-1</sup> (losses 16%), and anaerobic digestion of farmyard manure and organic residues of the farm and from organic waste coming from outside the farm 110 kg N ha<sup>-1</sup> (losses 16%).

Marchaim (1992) concludes from a literature review that control of pathogens by the thermophilic anaerobic process is more effective than aerobic fermentation.

### **1.3 Use of digestion residues**

The digestion residues of municipal waste biogas plants are usually separated into a liquid and solid fraction. Compost from the solid fraction is sold to hobby gardeners and landscape cultivating enterprises.

In contrast to slurry on-farm biogas plants, there is no knowledge about the properties of digestion residues of on-farm dry fermentation plants. Digestion residues of slurry improve the humus quality, reduce ammonium losses (Asmus et al. 1988, Asmus & Linke 1987), and may even improve yield of field crops (Koriath et al. 1985, Marchaim 1992).

Deuker et al. (2005) found that “fermentation of crop residues and catch crops increases to about 70% the mobile fertiliser pool but the productivity of the whole system is not higher, because a) about 50% of N is within the solid phase of fermentation residue with a wide C/N ratio ( $\approx 19$ ) and b) harvest and storage of crop residues and catch crops decreases the N-loss potential in winter (NO<sub>3</sub>, N<sub>2</sub>O), but other losses related to harvest, storage and mainly to spreading back on the soil in spring time are affecting the N use efficiency of the system.”

## 1.4 Economic assessment in respect of Finnish farms

The cost calculations made for the prototypes described in chapter 1.1 show that dry fermentation on farm is not economical. To compare the different solutions, we calculated the investment and the gas production cost. Figure 3 presents the results. We calculated the investment cost from the construction cost and the depreciation period. The gas production cost is the ratio of the investment cost and the gas produced during the depreciation period of the reactor. We estimated the construction cost at 5000 € for the dome and the foil cover reactor and at 300 000 € for the container reactor described by Kusch et al. 2005. We estimated the depreciation period at 20 years for the container reactors and at 10 years for dome and foil cover reactor. For the plastic bag reactor we estimated the VS at 84% of TS and the CH<sub>4</sub> content at 55%. All other figures are from the authors, see appendix 7.5.

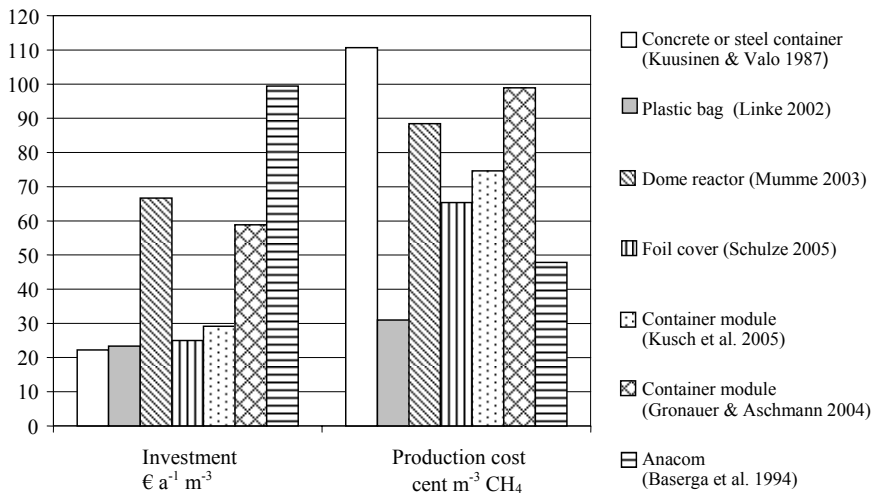

Figure 3. Comparison investment and gas production cost of on-farm dry fermentation plants.

In literature, we could not find any proof, that dry fermentation on farm is more competitive than wet fermentation. If we transfer the results from literature to Finnish conditions we state, that higher process energy demand due to the environmental conditions and lack of political and economical support in respect of renewable energy production on-farm hamper the competitive production of biogas.

## 2 Material and methods

We report about an innovative two-phase farm-scale biogas plant. The biogas plant in Järna was set up 2003 at the Yttereneby farm as demonstration plant related to the BERAS-project, a European Regional Development Fund INTERREG III B project. The goal is, by promoting a high degree of recycling, reduced use of non-renewable energy, and use of the best-known ecological techniques in each part of the system, to reduce consumption of limited resources and minimize harmful emissions to the atmosphere, soil, and water.

Comparison of dynamic, organic, and conventional farming systems (DOC) revealed in long term experiments, that the bio-dynamic system showed best results (Mäder et al. 2002) in respect of soil fertility and environmental pollution. Consequently, all farms at the local food area of Järna shown in figure 4 apply the biodynamic farming system, which includes the use of solid manure compost. The plant continuously digests dairy cattle manure and organic residues of the farm and the surrounding food processing units. The two phase reactor technology was chosen for two reasons: first, it offers the separation of a liquid fraction and a solid fraction for composting after hydrolysis and second, the methanation of the liquid fraction using fixed film technology results in a very short hydraulic retention time, reduction in reactor volume, and higher methane content of the biogas (Lo et al. 1984).

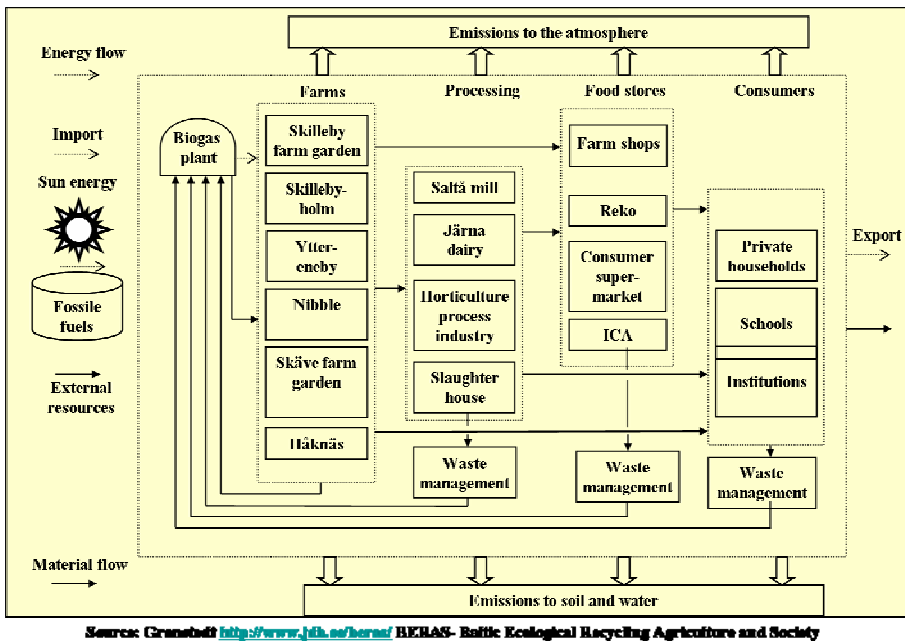

Figure 4. Environmental background of the biogas plant in Järna.

## 2.1 Technical documentation

To collect the technical data we visited the plant between 2003 and 2005 several times. Lars Evers, who set up the plant and operates it since November 2003 delivered the technical information for the plant details and recorded the gas yield, CO<sub>2</sub> content, reactor temperature and electrical power consumption.

The gas yield of each reactor was measured by a gas meter (Actaris G6 RF1) and the reading was daily recorded. Since autumn 2004, another gas meter (Krom-Schröder BK-G4T) was installed to record gas consumption of the boiler. CO<sub>2</sub>-content of the biogas was measured once by falling out soda in soda lye.

The weather station of biodynamic research institute in Järna recorded the weather data (mean day temperature and wind speed). The flow diagrams follow the SFS-EN ISO 10628 (2000) standard.

Figure 5 shows the principle of operation and the location of the sampling points.

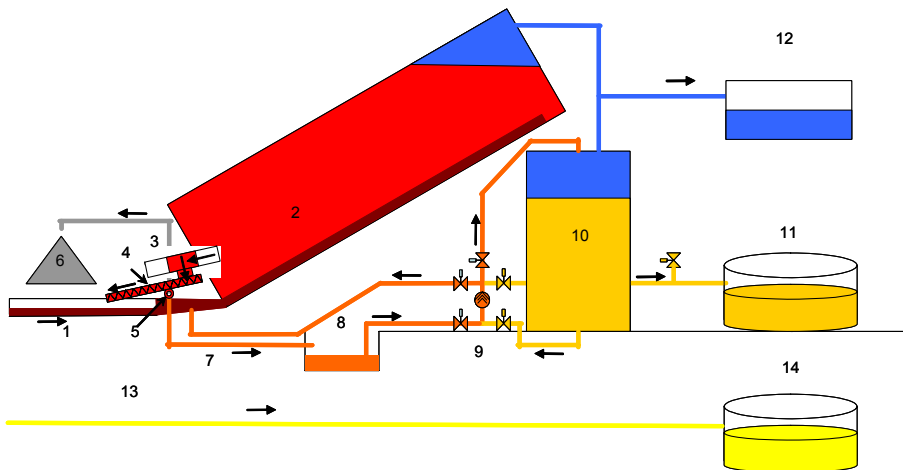

Figure 5. Principle of operation of the prototype biogas plant at Yttereneby farm, Järna, Sweden. 1 feeder channel, 2 first or hydrolysis reactor, 3 drawer, 4 drawer discharge screw, 5 solid residue separation screw, 6 solid residue after hydrolysis, 7 drain pipe of liquid fraction, 8 liquid fraction buffer store, 9 pump and valve, 10 second or methane reactor, 11 effluent store, 12 gas store, 13 urine pipe, 14 urine store

## 2.2 Sampling and analysis of organic matter

We weighed the daily solid manure input and the daily solid fraction output on 3.3.2004 and 26.10.2004. The daily spread litter (oat husks and straw) was weighed on 6.5.2004 and 26.10.2004 according to the information given by the farmer and his employees. To measure the quantity of the liquid fraction and of the effluent we recorded the level of the liquid fraction buffer store and the level of the final store respectively.

We took samples from the input (oat husks, straw, and manure) and the output of the first reactor (solid and liquid fraction) and the second reactor (effluent). First sampling was done on 3.3.2004 and total solids and nutrient content were analysed by HS Miljölab Ltd. in Kalmar, Sweden. Second sampling was done on 6.5.2004 and third sampling 26.10.2004 Total solids and nutrient content were analysed by HS Miljölab Ltd. in Kalmar, Sweden and Novalab Ltd. in Karkkila, Finland. Volatile solids were analysed at the laboratory of MTT/Vakola by heating samples for 3 h at 550 °C.

## 2.3 Composting experiments

For the compost trials (10.5.2004-13.8.2004 and 27.10.2004-16.3.2005), samples of 50 l manure and 50 l solid fraction from the hydrolysis reactor were aerobically digested at 15°C and 20°C respectively in the climate chamber of MTT/Vakola. The aerobic digestion took place in a bottomless 60 l plastic container set on a wire mesh shelf. During the trial period, we turned the samples three times and during the first trial, we added 1.3 l water. We recorded the environmental temperature and the process temperature during the composting period. Figure 6 shows the samples.



Figure 6. Compost trials. Left: solid fraction, right: manure. Picture: Marja Lehto.

## 2.4 Modelling material, nutrient, and energy flow

### 2.4.1 Mass balance

The following block diagram shows the material flow. The blue boxes describe the processes, the white boxes the input and output, and the yellow boxes digestion residues within the process:

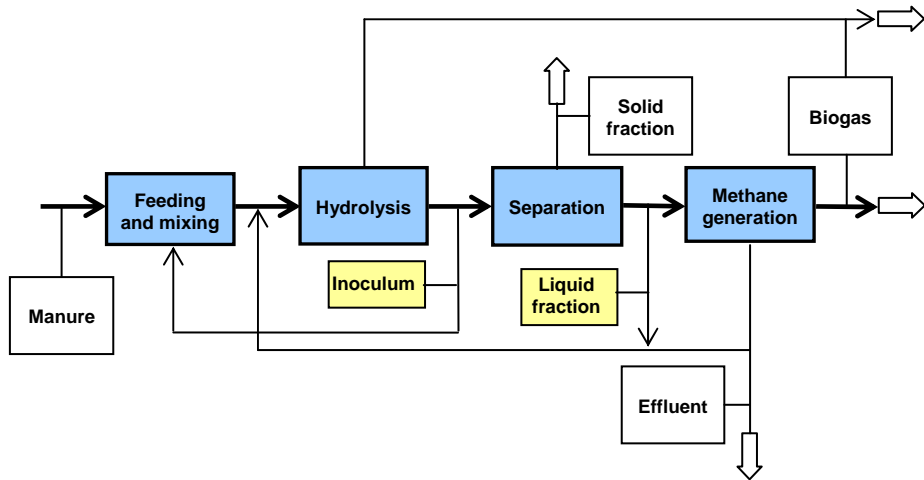

Figure 7. Block diagram of the biogas plant

Measuring mass flow of continuously working biogas plants at a specific date implies the risk of measuring errors. Especially the daily input of oat husks and straw vary widely depending on the person working in the stanchion bar. Farmers usually do not weigh and analyse the spread litter. The quantity and quality of faeces in terms of volatile solids depends on the quantity and quality of fodder, the metabolism of the animals and the environmental conditions like temperature, air humidity, and behaviour of farm staff and may change in a wide range. Number of animals varies by sale and birth. Therefore, we validated the measured masses by means of a linear equation system. Based on the law of conservation of mass we get equation 1:

$$M = S + E + B \quad (1)$$

M denotes fresh mass of manure, S mass of solid fraction of digestion residue, E mass of effluent and B mass of biogas. All masses, except of biogas, were recorded in  $\text{kg d}^{-1}$ . In respect of TS and VS, following equations are valid:

$$M \cdot \text{TS}_M = S \cdot \text{TS}_S + E \cdot \text{TS}_E + B - W \quad (2)$$



$$M \cdot VS_M = S \cdot VS_S + E \cdot VS_E \quad (3)$$

TS stands for total solids and VS volatile solids of each component respectively and W the mass of vapour in the biogas.

The input material is a mixture of faeces, straw and oat husks:

$$M = F + STR + H \quad (4)$$

M is manure, F faeces, STR straw and H oat husks in kg d<sup>-1</sup>. We calculated the mass of faeces by subtracting the weighed mass of straw and oat husk from the weighed mass of manure.

Because the biogas yield G was measured in cubic meters separately for both reactors, the calculation of the biogas mass B has to be calculated. The biogas consists of methane ME, carbon dioxide C, and vapour W. Other components of the biogas like sulphur and siloxanes are neglected. Since we measured only the CO<sub>2</sub> content in volume percent of the biogas yield, we estimate the vapour percentage. Referring to Weiland (2003) we assume, that 3 volume percent of the biogas is vapour. Further biogas is produced in both reactors denoted by indices: 1 for the hydrolysis reactor and 2 for the methane reactor.

$$B = G_1 \cdot ((\rho_{ME} \cdot (1-w-c_1)) + c_1 \cdot \rho_C + w \cdot \rho_W) + G_2 \cdot ((\rho_{ME} \cdot (1-w-c_2)) + c_2 \cdot \rho_C + w \cdot \rho_W) \quad (5)$$

$\rho_{ME}$  is the specific weight of methane, w the volume percentage of vapour, c the volume percentage of carbon dioxide in the biogas,  $\rho_C$  the specific weight of carbon dioxide, and  $\rho_W$  the specific weight of vapour.

For the calculation of biogas mass, we used following figures:  $\rho_C = 1.977 \text{ kg m}^{-3}$ , the  $\rho_{ME} = 0.717 \text{ kg m}^{-3}$ , and  $\rho_W = 0.804 \text{ kg m}^{-3}$ , valid at 0°C and 1.0132 bar barometric pressure (Brockmann 1987). Because the carbon dioxide measurement was done only once we use for  $c_1 = 40\%$  and for  $c_2 = 32\%$ . Using equation 5 to convert the biogas yield G into biogas mass B we get:

$$B = G_1 \cdot 1.22361 + G_2 \cdot 1.12281 \quad (6)$$

The mass of carbon dioxide is:

$$C = G_1 \cdot c_1 \cdot \rho_C + G_2 \cdot c_2 \cdot \rho_C \quad (7)$$

or

$$C = G_1 \cdot 0.7908 + G_2 \cdot 0.63264 \quad (8)$$

The mass of methane is:

$$ME = \rho_{ME} \cdot (G_1 \cdot (1-w-c_1) + G_2 \cdot (1-w-c_2)) \quad (9)$$

or

$$ME = G_1 \cdot 0.40869 + G_2 \cdot 0.46605 \quad (10)$$

The mass of vapour in biogas is:

$$W = (G_1 + G_2) \cdot w \cdot \rho_w \quad (11)$$

or

$$W = G \cdot 0.02412 \quad (12)$$

Using the equations 1-3 and the measured TS, VS, and gas yield, we calculated the mass of the solid fraction and the effluent:

$$S = \frac{B \cdot ((A_M - A_E) \cdot (TS_M - 1) - A_M \cdot (TS_M - TS_E)) + W \cdot (A_M \cdot A_E)}{(A_M - A_E) \cdot (TS_S - TS_M) - (TS_M - TS_E) \cdot (A_S - A_M)} \quad (13)$$

$$E = S \cdot \frac{A_S - A_M}{A_M - A_E} - A_M \cdot \frac{B}{A_M - A_E} \quad (14)$$

where  $A_M$ ,  $A_S$ ,  $A_E$  is the ash of each component calculated from the difference between total and volatile solids:

$$A_M = TS_M - VS_M \quad (15)$$

$$A_S = TS_S - VS_S \quad (16)$$

$$A_E = TS_E - VS_E \quad (17)$$

The calculated mass was then compared with the measured one. Finally, the recorded VS and TS values were adopted within the boundaries of measuring accuracy by an iteration algorithm to comply with the linear equation system.

Based on the results of the mass balance we calculated the load and the performance parameters of the biogas plant according to Linke et al. (2003).

Basic parameters are the input  $Q_{in}$  and the output  $Q_{out}$  of the organic material and the biogas yield of each reactor. The organic material input of the hydrolysis reactor is the manure; the input of the methane reactor is the liquid fraction from the hydrolysis reactor. The organic material output of the hydrolysis reactor is the solid fraction and the liquid fraction, the output of the

methane reactor is the effluent, see figure 7. The load rate depends on the capacity  $V$  of each reactor (see annex 7.8). We calculate the volume of the input and output by the following equations. The index 1 stands for the hydrolysis reactor and index 2 for the methane reactor:

$$Q_{1in} = M \cdot \rho_M^{-1} \quad (18)$$

For further anaerobic digestion in the methane reactor only the liquid fraction of the hydrolysis reactor is used:

$$Q_{1out} = (M - S - G_1 \cdot 1.22361) \cdot \rho_l^{-1} \quad (19)$$

$$Q_{2in} = Q_{1out} \quad (20)$$

$$Q_{2out} = E \cdot \rho_E^{-1} \quad (21)$$

We calculate the retention time  $t$  and loading rate  $l$  with the following equations:

$$t_1 = V_1 \cdot Q_{1in}^{-1} \quad (22)$$

$$t_2 = V_2 \cdot Q_{2in}^{-1} \quad (23)$$

$$l_1 = VS_M \cdot Q_{1in}^{-1} \cdot t_1^{-1} \quad (24)$$

We calculate the volatile solids of the liquid fraction from the difference between the volatile solids of manure and the solid fraction minus the biogas generated in the hydrolysis reactor:

$$l_2 = (VS_M - VS_S - G_1 \cdot 1.22361 \cdot \rho_l^{-1}) \cdot Q_{2in}^{-1} \cdot t_2^{-1} \quad (25)$$

We refer the yield rate  $y$  to the input of volatile solids and the volume efficiency  $v$  to the effective capacity of each reactor:

$$y_1 = G_1 \cdot 1000 \cdot VS_M^{-1} \quad (26)$$

$$y_2 = G_2 \cdot 1000 \cdot (VS_M - VS_S - G_1 \cdot 1.22361)^{-1} \quad (27)$$

$$v_1 = G_1 \cdot 1000 \cdot V_1^{-1} \quad (28)$$

$$v_2 = G_2 \cdot 1000 \cdot V_2^{-1} \quad (29)$$

## 2.4.2 Nutrient balance

The quantity of nutrients in faeces depends on the quantity and quality of fodder, the metabolism of the animals and the environmental conditions like temperature, air humidity, and behaviour of farm staff and may change in a wide range (Gruber & Steinwider 1996).

From the masses and the dry matter content of all components, we calculate the nutrient balance. From the laboratory analysis, we get the nutrient content  $X$  of each component. The difference between input and output is the loss  $L$  of nutrient  $X$ . Generally, we calculated the nutrient balance of the biogas plant as follows:

$$M \cdot TS_M \cdot X_M = S \cdot TS_S \cdot X_S + E \cdot TS_E \cdot X_E + L \quad (30)$$

where

$$M \cdot TS_M \cdot X_M = F \cdot TS_F \cdot X_F + STR \cdot TS_{STR} \cdot X_{STR} + H \cdot TS_H \cdot X_H \quad (31)$$

Because the solid fraction is further composted, the final output embraces the nutrients of the compost of the solid fraction  $SC$  and the nutrients of the effluent:

$$M \cdot TS_M \cdot X_M = SC \cdot TS_{SC} \cdot X_{SC} + E \cdot TS_E \cdot X_E + L_A \quad (32)$$

We name the entire process of anaerobic digestion followed by aerobic composting of the solid fraction as process A. Consequently, we name the mere aerobic composting of manure as process B and the output as manure compost  $MC$ .

$$M \cdot TS_M \cdot X_M = MC \cdot TS_{MC} \cdot X_{MC} + L_B \quad (33)$$

Finally, we compared the nutrient losses of both processes to evaluate the pros and cons of aerobic and anaerobic/aerobic treatment of solid manure.

The error margin of the laboratory analyses (see appendix 7.4) has to be taken into consideration evaluating the results presented in chapter 3. The error margin of N-content may reach up to 50%. Because of the low number of samples, none of the results presented in chapter 3 can be confirmed statistically.

### 2.4.3 Energy balance

Figure 8 shows the energy flow of the biogas plant. The energy input demand  $Q_I$  depends on the temperature and the mass of input material, the environmental daily mean temperature, the wind speed, and of heat energy for heating the input material. It is approximately calculated by following equation:

$$Q_I = Q_H + Q_R + Q_E \quad (34)$$

where  $Q_H$  is the energy required to heat the input material (first reactor: manure, second reactor: liquid fraction of the first reactor),  $Q_R$  the energy to maintain the process temperature of the reactor and  $Q_E$  the electric power to run the electric motors for mass transfer equipment. The energy required to heat the input material up to the process temperature  $t_i$  is calculated on the assumption, that the temperature of the input material is the same as the average daily mean temperature  $t_a$ . Because the specific heat capacity of the input material is unknown, we assume that it is equal to the specific heat capacity of water:

$$Q_H = (M + E) \cdot 1.17 \text{ W h kg}^{-1} \text{ K}^{-1} \cdot (t_i - t_a) \quad (35)$$

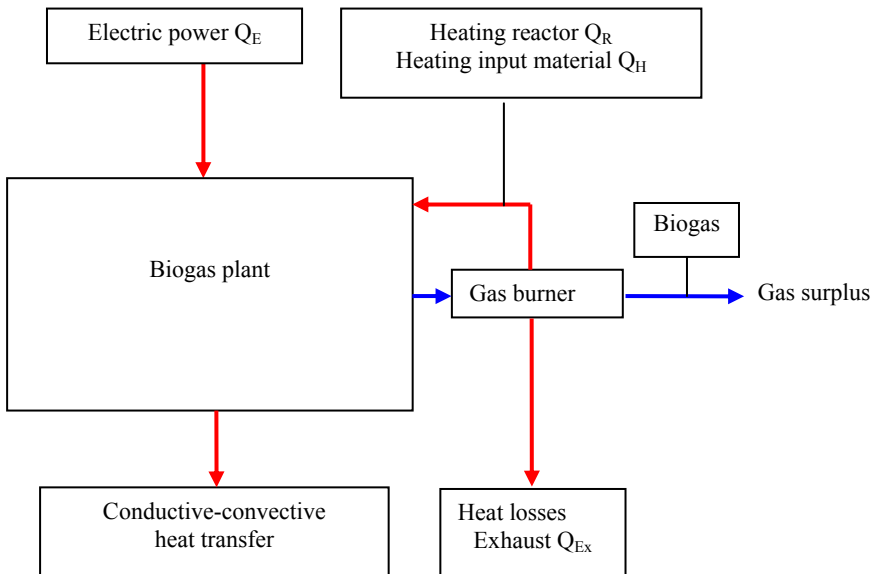

Figure 8. Energy flow of the biogas plant

The energy to heat the reactor  $Q_R$  is equal to the conductive-convective heat transfer of the reactor surface to the environment and is approximately calculated with the following equations:

$$Q_R = k \cdot A \cdot (t_i - t_a) \cdot 24 \text{ h d}^{-1} \quad (36)$$

Where A names the reactor surface and k the k-value, which is calculated by equation (37):

$$k = 1 / (1 / \alpha_{\text{substrate/steel}} + d_{\text{steel}} / \lambda_{\text{steel}} + d_{\text{cellulose}} / \lambda_{\text{cellulose}} + d_{\text{air}} / \lambda_{\text{air}} + 1 / \alpha_{\text{metal/air}}) \quad (37)$$

The heat transfer coefficient  $\alpha$  and the thermal conductivity coefficient  $\lambda$  of the reactor wall elements are compiled in table 5:

Table 5. Parameters for calculation of the conductive-convective heat transfer of the reactor surfaces.  $\alpha$  heat transfer coefficient, d wall thickness,  $\lambda$  thermal conductivity, t temperature

Parameter	Unit	Value	Source
$\alpha_{\text{substrate/steel}}$	$\text{W m}^{-2} \text{K}^{-1}$	382	Estimated
$d_{\text{steel}}$	m	0.01	Measured
$\lambda_{\text{steel}}$	$\text{W m}^{-1} \text{K}^{-1}$	40	Brockmann 1987
$d_{\text{cellulose}}$	m	0.2	Measured
$\lambda_{\text{cellulose}}$	$\text{W m}^{-1} \text{K}^{-1}$	0.041	Estimated
$d_{\text{air}}$	m	0.02	Estimated
$\lambda_{\text{air}}$	$\text{W m}^{-1} \text{K}^{-1}$	0.024	Brockmann 1987
$\alpha_{\text{metal/air}}$	$\text{W m}^{-2} \text{K}^{-1}$	13.9	Estimated

The electric power consumption of the whole plant was recorded by a separate meter. From the measured gas consumption of the gas burner  $G_B$  and the calculated energy input for process heating, we calculated the heat losses in the exhaust gases of the burner:

$$Q_{\text{Ex}} = G_B \cdot c \cdot 10^4 \text{ W h m}^{-3} - Q_M - Q_R \quad (38)$$

Where c is the average volume percentage of carbon dioxide in the biogas, which is derived from the biogas yield of both reactors:

$$c = (G_1 \cdot c_1 + G_2 \cdot c_2) \cdot (G_1 + G_2)^{-1} \quad (39)$$

## 2.5 Cost benefit analysis

The costs of biogas production depend on the investment cost for the biogas plant and the operational cost. Operational costs depend on working hours, material input cost, and maintenance and repair cost. These factors are mainly dependent from type of process technology, stability of the fermentation process, environmental conditions as well as from quantity and quality of the organic input material. The quantity of volatile solids in the input material decides about the biogas yield. The quality of the input material in respect of the biogas potential is expressed by the methane generation rate measured in litre methane per kg volatile solids.

The benefit of the biogas production depends on compensation for organic waste disposal, gas price, nutrient value of digestion residues, and reduction of environmental pollution.

The biogas plant generates income, if either farm waste disposal fees can be saved or if waste disposal fees are paid to the farmer for organic material coming from outside the farm. The value of the biogas depends on the energy mode. Heat usually is simply to produce by burning the biogas, but wood is generally much more competitive for heat production. A value adding effect on-farm can be achieved, if the exhaust gases from biogas combustion are used as carbon dioxide manure in glasshouses (Schäfer 2003).

If the gas is cleaned, it can be used as fuel for combustion engines to power an electric generator (CHP-unit). In this case, the biogas value corresponds to the price of electric power and the price of heat that may be compensated using waste heat of the CHP-unit. An important economical factor of a CHP-unit may also be the independency from power cuts caused by natural hazards.

After cleaning and carbon dioxide removal, the compressed biogas can be used as fuel for LPG engine cars. In this case, the value of the biogas is related to the fuel price.

All energy conversion technologies include energy losses. Therefore, the conversion efficiency has to be taken into consideration to compare the different alternatives. The gross heat energy of the biogas minus the process heat energy required is the net heat energy available for production of heat, electric power, or LPG fuel. In table 6, an example calculation considers all the above-mentioned factors. It shows the wide range of on-farm biogas production potential. The calculations are valid for both dry and wet fermentation. As input material, we choose manure from one dairy cows and organic material including both farm waste and waste from outside the farm.

Table 6. Range of income from biogas production depending on lower and upper limits of input and process parameters. Typical values: cow manure as mixture of straw and excreta; organic material as clover grass silage.

Input							
	unit	manure of one cow			100 kg organic material		
		lower	typical	upper	lower	typical	upper
Fresh mass FM	kg d <sup>-1</sup>	20	35	50	100	100	100
Content of volatile solids VS	% of FM	10	18	20	15	20	100 <sup>a</sup>
Volatile solids	kg VS d <sup>-1</sup>	2	6.3	10	15	20	100
Process data							
Biogas generation	l kg <sup>-1</sup> VS	160	250	500	160	250	800
Methane content	%	55	60	65	55	60	65
Heat value of methane	kWh m <sup>-3</sup>	9.12	9.9	10.13	9.12	9.9	10.13
Process heat, % of gross heat	%	50	25	10	50	25	10
Efficiency electric power production	%	25	30	35	25	30	35
Efficiency heat production	%	80	85	90	80	85	90
Efficiency LPG fuel production <sup>b</sup>	%	70	80	85	70	80	85
Prices							
Price electric power	c kWh <sup>-1</sup>	2.90 <sup>c</sup>	6.00	10.00	2.90	2.00	10.00
Price heat	c kWh <sup>-1</sup>	2.00 <sup>d</sup>	4.00	6.00 <sup>e</sup>	2.00	2.00	6.00
Price fuel	c kWh <sup>-1</sup>	13.33 <sup>f</sup>	13.00	14.44 <sup>f</sup>	10.00	13.00	15.00
Calculated results							
Biogas yield	l d <sup>-1</sup>	320	1575	5000	3200	3750	80000
Methane yield	m <sup>3</sup> d <sup>-1</sup>	0.18	0.95	3.25	1.76	2.25	52.00
Gross heat energy	kWh d <sup>-1</sup>	1.61	9.36	32.92	16.05	22.28	526.76
Net heat energy	kWh d <sup>-1</sup>	0.80	7.02	29.63	8.03	16.71	474.08
Electric power only	kWh d <sup>-1</sup>	0.40	2.81	11.52	2.01	5.01	165.93
Heat only	kWh d <sup>-1</sup>	0.64	5.96	26.67	6.42	14.20	426.68
Fuel only	kWh d <sup>-1</sup>	0.56	5.61	25.19	5.62	13.37	402.97
Income, electric power only	€ d <sup>-1</sup>	0.01	0.17	1.15	0.06	0.30	16.59
Income, heat only	€ d <sup>-1</sup>	0.01	0.24	1.60	0.13	0.57	25.60
Income, heat and electric power	€ d <sup>-1</sup>	0.01	0.30	2.11	0.15	0.71	33.77
Income, LPG fuel only	€ d <sup>-1</sup>	0.07	0.77	3.64	0.75	1.84	58.21

<sup>a</sup> for example glycerine

<sup>b</sup> cleaning and compression of biogas for LPG-fuel (Schwarz 2004)

<sup>c</sup> selling price

<sup>d</sup> energy price from wood chips

<sup>e</sup> light fuel oil price

<sup>f</sup> petrol E95 price 1.20 – 1.30 € l<sup>-1</sup>, 9 kWh l<sup>-1</sup>



From the results in table 6 we calculated that an assumed turn over of 50 000 € a<sup>-1</sup> requires the manure of 38 – 1826 livestock units (LU), typically 105 LU or 0.235 -18.2 t organic matter d<sup>-1</sup>, typically 7.5 t clover grass silage d<sup>-1</sup> if the biogas is used for LPG fuel. The biogas plant including the biogas fuel processing unit will work economically only, if the sum of capital, work, maintenance, and operating costs remains below 50 000 € a<sup>-1</sup>. The reactor volume will be about 350 m<sup>3</sup>. Supposed the reactor costs 1 000 €/m<sup>3</sup> and the fuel processing unit 150 000 € than the overall investment cost will reach 500 000 €. For dry fermentation of cow manure, a reactor volume of 175 m<sup>3</sup> may be sufficient. The results show that farm specific conditions finally decide about the profitability of biogas production. Usually on-farm biogas production using only farm residues is not yet profitable. Garrison & Richard 2005 calculated similar results. E.g. for dairy cows the break-even point for methane recovery facilities was between 119 and more than 5000 LU.

Generally, four parameters determine the economy of biogas production on-farm: Income from waste disposal services, compensation for reduction of greenhouse gas emission, compensation for energy production and - most important for sustainable agriculture - nutrient recycling benefits.

Hagström et al. (2005) confirmed these findings in an internal report for the Finnish Ministry of Agriculture and Forestry.

### 3 Results

#### 3.1 Technical documentation of the biogas plant in Järna

The biogas plant is located at Järna/Sweden about 50 km south of Stockholm on the Yttereneby-farm. The plant is designed to digest solid manure of 65 LU dairy cattle and organic waste of the surrounding food processing units.

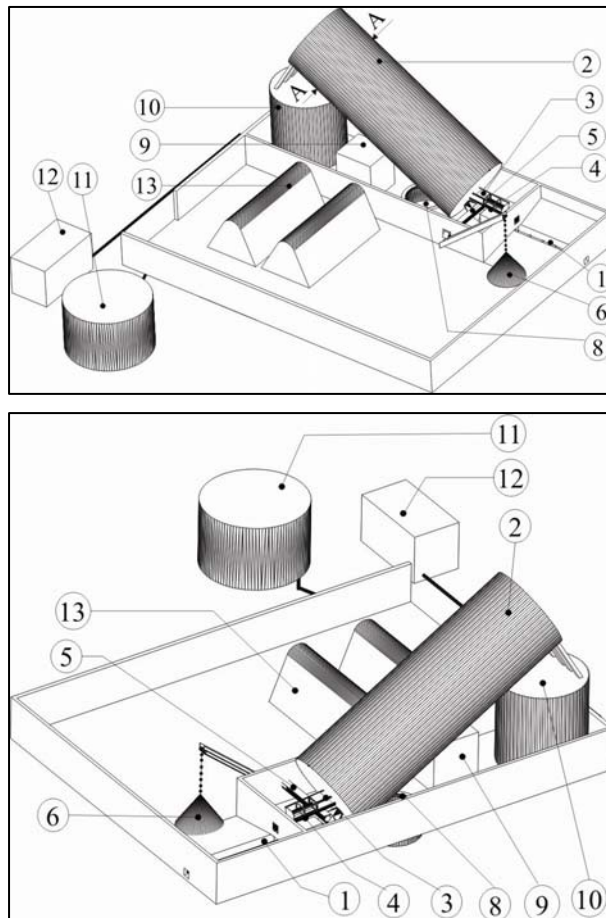

Figure 9. View of the biogas plant. 1 hydraulic powered scraper, 2 hydrolysis reactor, 3 drawer, 4 feeder channel, 5 extruder, 6 solid fraction, 7 drain pipe of the liquid fraction (not visible), 8 buffer container of the liquid fraction, 9 control room with pump and burner, 10 methane reactor, 11 effluent store, 12 container with gas bag, 13 compost heap of solid fraction

### 3.1.1 Design and material flow

The block diagram of figure 5 may be helpful to illustrate the material flow described here. Both reactors are made of COR-TEN-steel cylinders of 10 mm wall thickness and 2.85 m inner diameter formerly used as smoke-stack. They are coated by 20 cm pulp isolation and corrugated sheet, figure 10.

A hydraulic powered scraper shifts manure from 65 adult bovine units kept in a dairy stanchion stall into the feeder channel of the hydrolysis reactor. The urine is separated in the stall via a perforated scraper floor. The manure is a mixture of faeces, straw and oat husks. From the feeder channel the manure is pressed by another hydraulic powered scraper (180 bars, 2700 mm stroke) via a 400 mm wide feeder pipe to the top of the 30° inclined hydrolysis reactor of 53 m<sup>3</sup> capacity. The bottom of the hydrolysis reactor is on both sides of the feeder pipe provided with hot water channels, see figure 10.

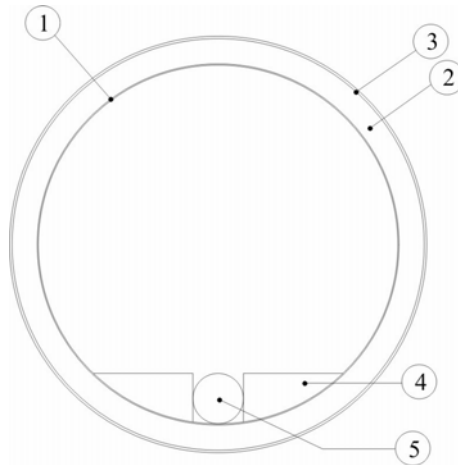

Figure 10. Cross section A-A of the hydrolysis reactor. 1 COR-TEN steel cylinder 10 mm, 2 pulp isolation 200 mm, 3 corrugated sheet, 4 heating channel, 5 PVC feeder pipe.

Gravitation slowly pulls the manure down mixing it with the substrate. After a hydraulic retention time of about 22 to 25 days at 38°C, the substrate is discharged through a bottomless drawer in the lower part of the reactor. The drawer is guided within a rectangular channel and powered by a hydraulic cylinder (180 bar, 1000 mm stroke). Every drawer cycle removes about 0.1 m<sup>3</sup> substrate from the hydrolysis reactor to be discharged into the transport screw beneath (Spirac, Ø 260 mm), see figure 11.

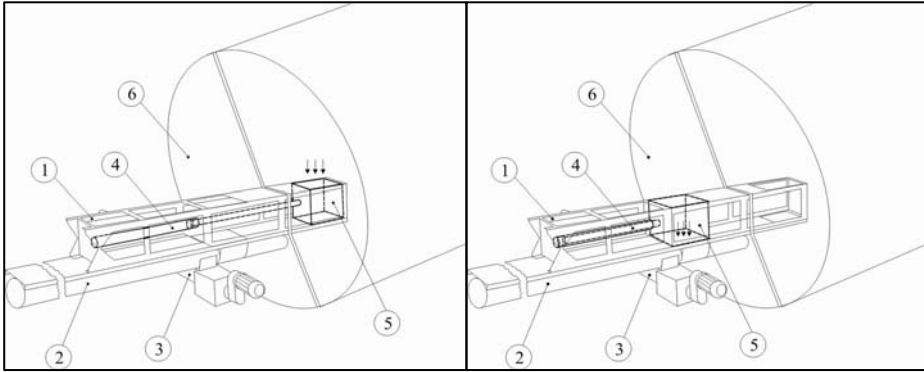

Figure 11. Function of the drawer. Left: filling, right: discharging. 1 frame, 2 transport screw, 3 extruder, 4 hydraulic cylinder, 5 bottomless drawer, 6 hydrolysis reactor

From the transport screw the major part of the substrate partly drops into a down crossing extruder screw (Spirac, Ø 200 mm) where it is separated into solid and liquid fractions. The remaining material in the transport screw is conveyed back to the feeder channel and inoculated into the fresh manure. The solid fraction from the extruder screw is stored in the dung yard for composting.

The liquid fraction is collected in a buffer container of 2 m<sup>3</sup> capacity and from there pumped into the methane reactor. Liquid from the buffer container and from the methane reactor partly returns into the feeder pipe of the hydrolysis reactor to improve the flow ability. The methane reactor is 4 m high and filled with about 10 000 filter elements offering a large surface area for methane bacteria settlement. The effective reactor capacity is 17.6 m<sup>3</sup>. After an hydraulic retention time of 15 to 16 days at 38°C, the effluent is pumped into a slurry store covered by a floating canvas. A screw pump (Pumpenfabrik Wangen, Typ KL 30S-500)

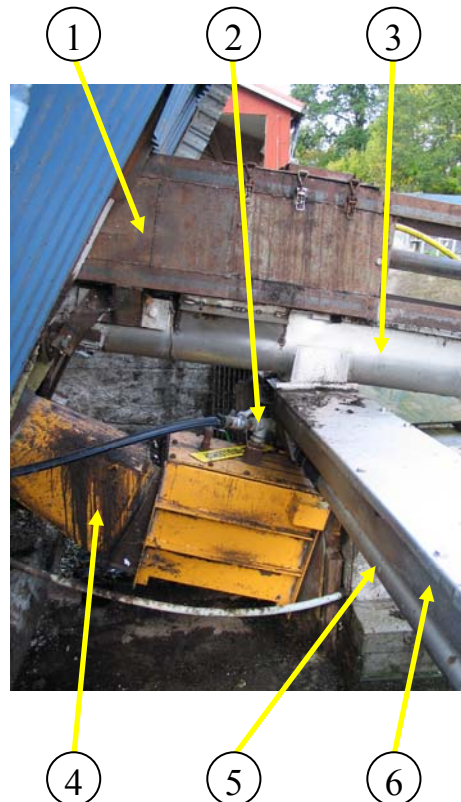

Figure 12. Filling and discharging the hydrolysis reactor. 1 frame of the drawer, 2 recycling of liquid fraction for lubrication of the feeder channel, 3 transport screw, 4 feeder channel, 5 drain pipe for liquid fraction, 6 extruder screw

conveys all liquids supported by four pressurized air-driven valves. The gas generated in both reactors is collected and stored in a sack. A compressor generates 170 mbar pressure to supply the burners of the process and estate boiler with biogas for heating purposes.

Gas dewatering, gas pressure regulation and overpressure relief is regulated by water columns within two heated water containers, figure 13. Condensation water in the gas pipe between water container and gas sack is blown out on demand. For this purpose, the valves 5 are switched in such a position, that the compressor blows out water and methane into the atmosphere. Desulphurization of the biogas did not take place in the first measuring period 2003-2004. Since autumn 2004, ferrous oxide is used.

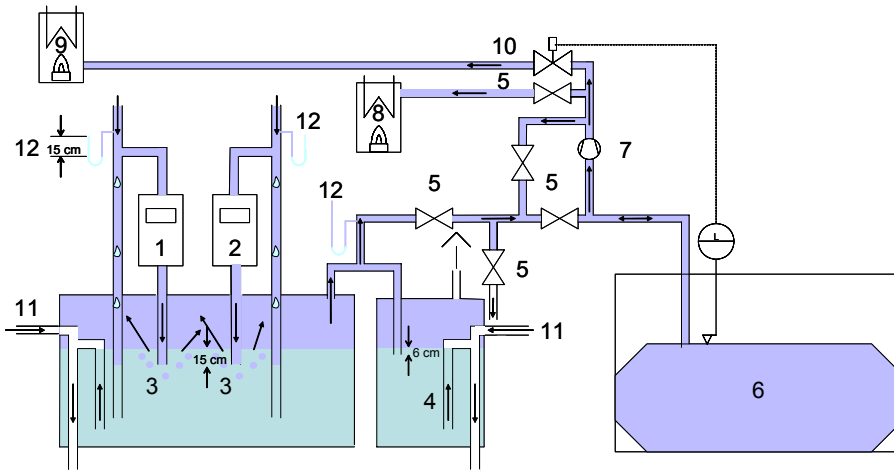
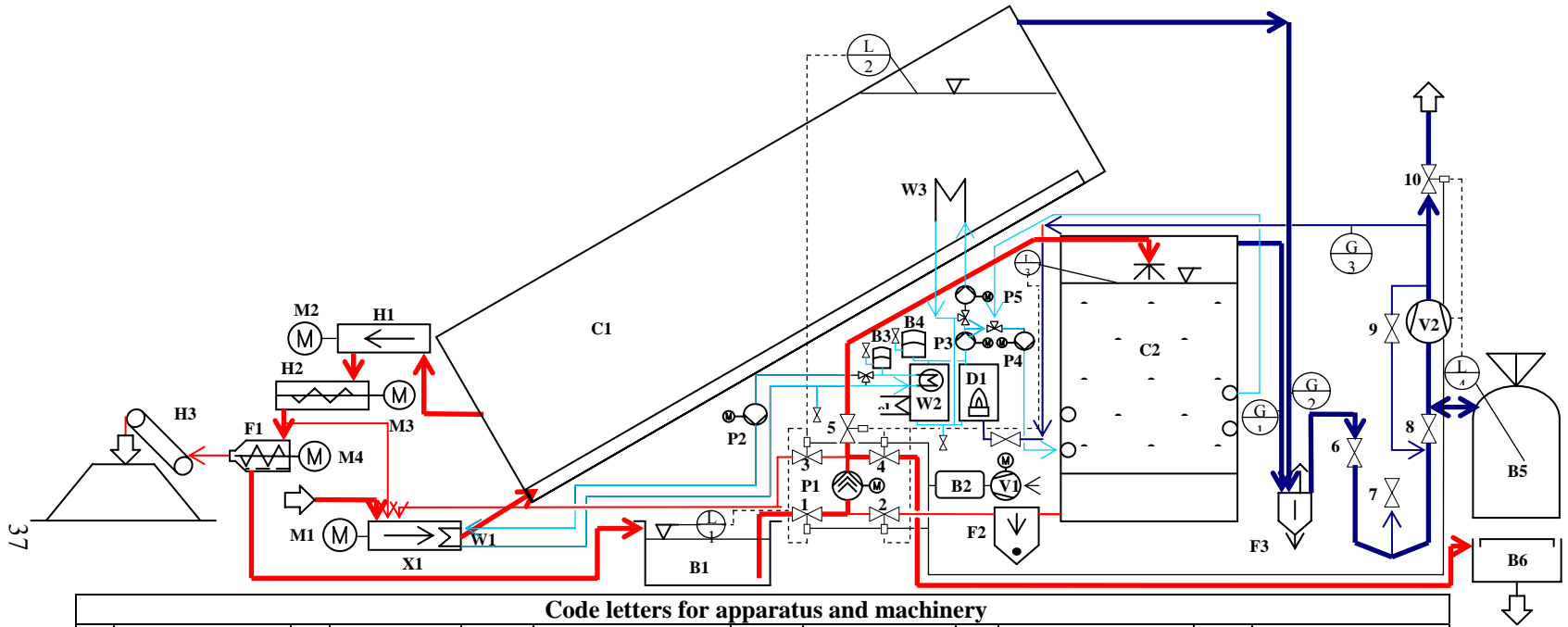

Figure 13. Water separation, pressure control of gas circuit. 1 Gas meter hydrolysis reactor, 2 Gas meter methane reactor, 3 Water bin for 15 mbar gas pressure control of the reactors, 4 Water bin for 4 mbar gas pressure control of the gas store, 5 Valves for dewatering gas pipe, 6 Gas bag, 7 Gas compressor, 8 Burner for process heating, 9 Furnace estate, 10 Valve pressure air operated, 11 Dewatering pipe, 12 Pressure gauge

A PLC (Mitsubishi FX 2N 48 MR) controls the biogas plant is automatically. Figure 14 shows the process flow diagram of the whole biogas plant.



37

Code letters for apparatus and machinery											
B1	Buffer	B2	Pressure air tank	B3-B4	Expansion tanks	B5	Gas sack	B6	Effluent store	C1	Hydrolysis reactor
C2	Methane reactor	D1	Burner	F1	Extruder	F2	Granulate separator	F3	Water separator	H1	hydraulic powered drawer
H2	Transport screw	H3	Conveyor belt	M1, M2	Motors of hydraulic pumps	M3, M4	Gear motors	P1	Screw pump	P2-P5	Hot water pumps
V1	Pressure air compressor	V2	Gas compressor	W1	Heating feeder channel	W2	Boiler	W3	Heating hydrolysis reactor	X1	hydraulic powered scraper
Code numbers of the valve											
1-5 Valves for substrate flow control				6-9 Valves for dewatering gas pipe				10 Gas valve estate heating			

Code letters for measurement and control functions													
$\frac{L}{1}$	Level sensor of buffer	$\frac{L}{2}$	Level sensor hydrolysis reactor	$\frac{L}{3}$	Level sensor methane reactor	$\frac{L}{4}$	Level sensor gas sack	$\frac{G}{1}$	Gas meter methane reactor	$\frac{G}{2}$	Gas meter hydrolysis reactor	$\frac{G}{3}$	Gas clock burner

Figure 14. Process flow diagram of the whole biogas plant.

### 3.1.2 Mass balance

The biogas production of the plant started in 15<sup>th</sup> of November 2003. The biogas production until the beginning of the pasture period 8<sup>th</sup> of May 2004 is shown in figure 15. A frozen gas pipe biased the gas yield measuring results in January and corrosion problems in the gas pipe of the hydrolysis reactor impeded correct measurement of the gas yield in April. The actual cumulative gas yield may therefore be higher than the measured one.

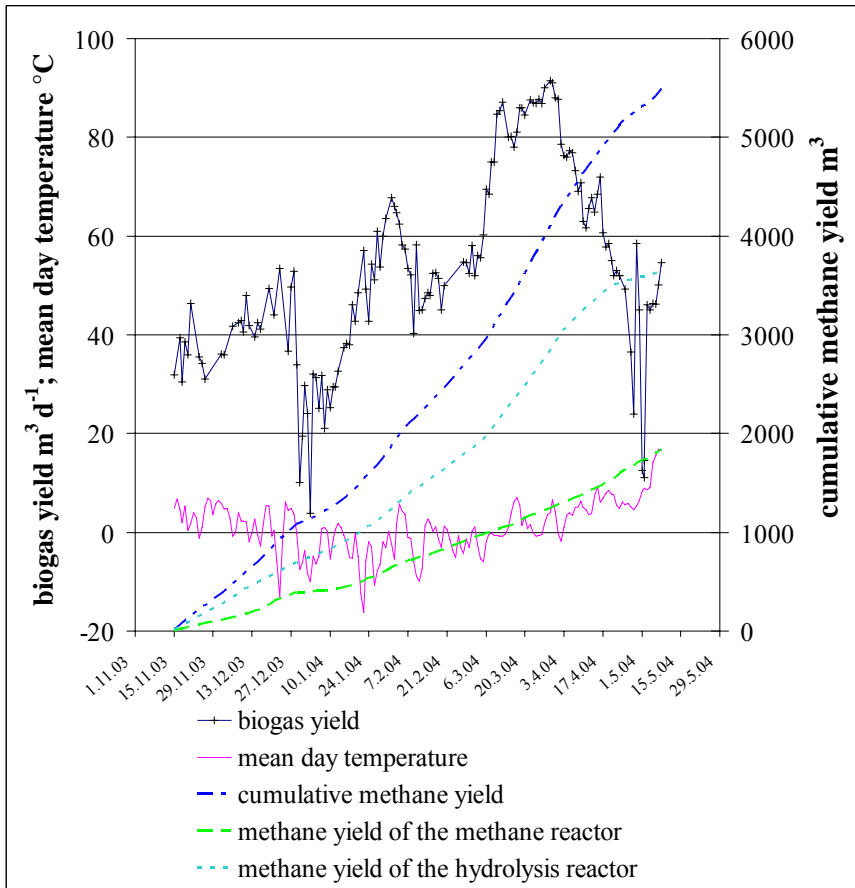

Figure 15. Biogas and methane yield during the first measuring period between 15<sup>th</sup> of November 2003 and 7<sup>th</sup> of May 2004.

In the hydrolysis reactor we measured 40% carbon dioxide and in the methane reactor 32%. Using equation (39) results in an average methane content of 59.5%.

The second biogas yield recording period started 3<sup>rd</sup> of September 2004 and ended 26<sup>th</sup> of October because the gas yield decreased dramatically. The records are shown in figure 16.

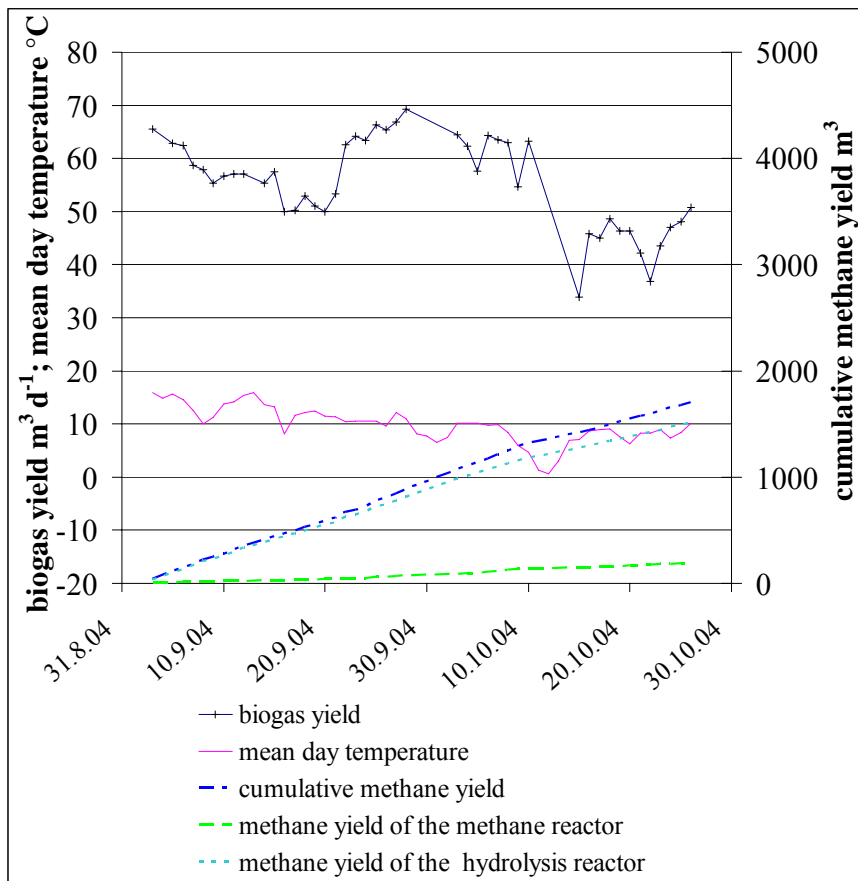

Figure 16. Biogas and methane yield during the first measuring period between 2<sup>nd</sup> September 2004 and 26<sup>th</sup> October 2004

In autumn 2004, no carbon dioxide content records were available. Supposing the same values as in the first period, equation (39) results in an average methane content of 57.8%.

Table 7 shows the average biogas yield and its components of both measuring periods and the maximum yields. Notice that the maximum yield of the whole plant does not coincide with the maximum yield of each reactor. Because we measured the mass input on single days, there are no daily organic input records. Therefore, we calculated the mass balance assuming the values in table 8, which were as close as possible to the measured values of the sampling day and fulfilled the linear equation system (1), (2) and (3) of chapter 2.4.1.



Table 7. Mean and maximum daily biogas yield of two measuring periods and biogas yield during sampling days. R1 hydrolysis reactor, R2 methane reactor.

Reactor	R1	R2	R1+R2	R1	R2	R1+R2
Mean m <sup>3</sup> d <sup>-1</sup>	15.11.03 - 8.5.04			3.9. - 26.10.04		
Biogas yield	36.40	16.14	52.54	49.21	5.42	54.63
%	69.28	30.72	100.00	90,08	9,92	100.00
Methane yield	20.75	10.49	31.24	28.05	3.52	31.75
Carbon dioxide yield	14.56	5.16	19.72	19.69	1.73	21.41
Vapour	1.09	0.48	1.58	1.48	0.16	1.64
Maximum m <sup>3</sup> d <sup>-1</sup>	23.3.04	29.4.04	29.3.04	27.9.04	8.10.04	28.9.04
Biogas yield	74.00	37.57	91.48	60.06	16.16	69.32
Methane yield	42.18	24.42	54.39	34.23	10.5	40.06
Carbon dioxide yield	29.60	12.02	34.34	24.02	5.17	27.18
Vapour	2.22	1.13	2.74	1.80	0.48	2.08

The masses of the biogas and its components were calculated employing equations (6), (8), (10), and (12).

Table 8. Assumed values of gas yield for mass balance calculation

	R1	R2	R1+R2	R1	R2	R1+R2
	spring			autumn		
Biogas yield m <sup>3</sup> d <sup>-1</sup>	28.9	19.2	48.1	47.0	5.2	52.3
%	60.0	40.0	100.0	90.0	10.0	100.0
Biogas mass kg	35.3	21.6	56.9	57.6	5.9	63.4
Methane mass kg	11.8	9.0	20.8	19.2	2.4	21.7
Carbon dioxide mass kg	22.8	12.2	35.0	37.2	3.3	40.5
Vapour kg	0.7	0.5	1.2	1.1	0.1	1.3

In contrast to the design calculations, the methane reactor produced less gas than the hydrolysis reactor. The methane reactor generated in average in the first period 34 vol% and in the second period 11 vol% of the methane. This indicates that the process management has to be improved in such a way, that the load rate of the first reactor is reduced and the load rate of the second reactor is increased.

In spring, we measured about 2 Mg d<sup>-1</sup> input of fresh manure, in autumn about 2.4 Mg d<sup>-1</sup>. Based on the daily spread mass of husk and straw we calculated the proportion of faeces in the manure. Table 9 shows the results of the mass balance.

Table 9. Mass balance of fresh mass FM, total solids TS, and volatile solids VS.

Mass	FM kg d <sup>-1</sup>		TS kg d <sup>-1</sup>		VS kg d <sup>-1</sup>	
	Spring	Autumn	Spring	Autumn	Spring	Autumn
Year 2004						
Input faeces	1717	2172	123	199	99	176
Input straw	27	58	24	44	23	37
Input oat husks	256	198	238	181	218	162
<b>Sum input</b>	<b>2000</b>	<b>2428</b>	<b>385</b>	<b>423</b>	<b>340</b>	<b>375</b>
Output solid fraction	920	1188	271	317	243	282
Output effluent	1023	1176	58	45	41	32
Output biogas	57	63	56	62	56	62
<b>Sum output</b>	<b>2000</b>	<b>2427</b>	<b>385</b>	<b>423</b>	<b>340</b>	<b>375</b>

From oat husks and straw, originate 53 to 70% of the volatile solids of the input material. In the solid fraction remained 70 to 75% of the total solids, in the effluent 10 to 15% and within the biogas 14.8 to 14.9%. Based on the results presented in table 8 and 9 we calculated the load and the performance parameters in table 10 of the biogas plant.

Table 10. Load and performance parameters of the reactors of the biogas plant in Järna

Year 2004		R1	R2	R1+R2	R1	R2	R1+R2
		Spring			Autumn		
Effective capacity	m <sup>3</sup>	53	18	71	53	18	71
Mass input	kg FM d <sup>-1</sup>	2000	1045	2000	2430	1184	2430
Specific weight input	kg m <sup>-3</sup>	946	968		989	1015	
VS input	kg VS d <sup>-1</sup>	340	61	340	375	35	375
Biogas mass	kg d <sup>-1</sup>	35	22	57	58	6	63
Methane mass	kg d <sup>-1</sup>	12	9	21	19	2	22
Output mass	kg FM d <sup>-1</sup>	1045	1023		1184	1176	
VS output	kg VS d <sup>-1</sup>	61	40		35	30	
Retention time	d	25	16		22	15	
Loading rate	kg VS m <sup>-3</sup> d <sup>-1</sup>	6	3		7	2	
Biogas yield	l kg <sup>-1</sup> VS	85	313	141	125	147	139
Methane yield	l kg <sup>-1</sup> VS	48	204	85	71	96	80
Volume efficiency	l m <sup>-3</sup> d <sup>-1</sup>	544	1093	681	887	297	740

Notice, that the solid fraction is removed after digestion of the manure in the first reactor. Therefore, the loading rate and the yield rate cannot be calculated for the whole plant. This methodical problem makes it difficult to compare this plant with one-phase plants. The output mass of the first reactor is the liquid fraction and the output mass of the second reactor is the effluent.

The results confirm that the first reactor is overloaded and the production potential of the second reactor is not utilised. Recommended load rate for dairy manure is 3 to 5 kg VS m<sup>-3</sup> d<sup>-1</sup> in one-phase reactors (Linke et al. 2003). This value is probably suitable for the first reactor too. Fixed film reactors like the second reactor can work with a loading rate of 32.8 kg VS m<sup>-3</sup> d<sup>-1</sup> at the same biogas yield level (Lo et al. 1984).

Consequently, the average methane yield of 80 to 85 l CH<sub>4</sub> kg<sup>-1</sup> VS is low compared to findings of other dry fermentation plants. Baserga et al. (1994) reached 186 l CH<sub>4</sub> kg<sup>-1</sup> VS from straw and manure of beef cattle. Møller et al. (2004) measured 100 to 161 l CH<sub>4</sub> kg<sup>-1</sup> VS from dairy cattle faeces and 100 l CH<sub>4</sub> kg<sup>-1</sup> VS from straw at 40 days retention time.

The volume efficiency of the plant is slightly better than the average of common slurry fermenters. Oechsner et al. (1998) evaluated 66 plants and measured in average 630 l biogas m<sup>-3</sup> d<sup>-1</sup>. The latest evaluation Bundesforschungsanstalt für Landwirtschaft (FAL) (2006) shows similar values. Most (70%) of the 59 evaluated plants achieved a volume efficiency of 250 to 750 l biogas m<sup>-3</sup> d<sup>-1</sup>.

Figure 17 shows a comparison of the methane production and reactor productivity. The Kalmari plant near Jyväskylä in Finland is digesting dairy slurry continuously and the Anacom plant is a continuously working solid manure digesting plant, see chapter 1.1. The produced methane in terms of volatile solids destroyed ranges between 0.48 and 0.51 l CH<sub>4</sub> kg<sup>-1</sup> VS destroyed in

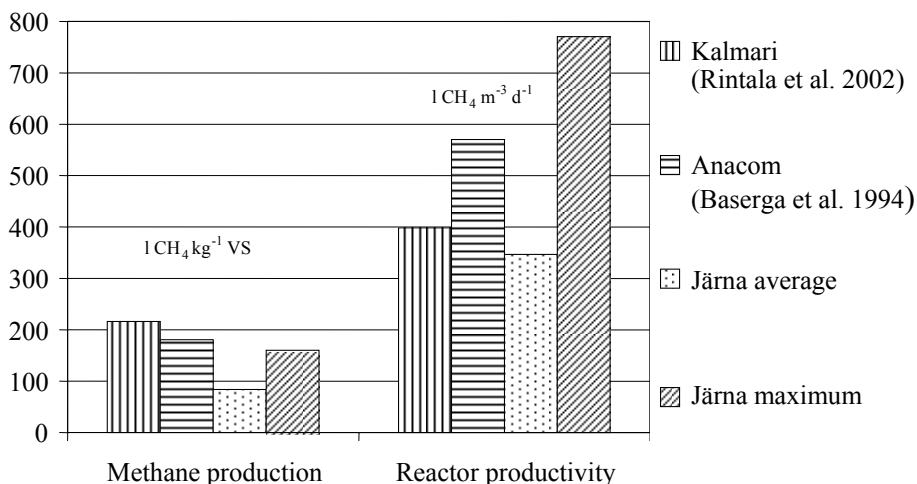

Figure 17. Comparison of the Järna biogas plant with continuously working slurry (Kalmari) and solid manure (Anacom) digesting plants.

spring and autumn respectively. The first reactor produced 0.47 and the second reactor 0.58 l CH<sub>4</sub> kg<sup>-1</sup> VS destroyed. These values are in line with previous findings reported by Hill (1984).

### 3.1.3 Nutrient balance

Before the biogas plant in Järna was established, the manure was aerobically composted. Nitrogen losses of aerobic digestion can reach more than 50% (Tiquia et al. 2002). During the anaerobic process, nitrogen cannot escape. Therefore, we calculated the nutrient balance of both the anaerobic digestion of manure followed by aerobic digestion of the solid fraction as process A and the mere aerobic digestion of manure as process B, see chapter 2.4.2.

Based on the mass balance results and the laboratory analysis concerning the nutrient content of the different organic material of both processes we calculated the results compiled in table 11.

Table 11. Nutrient content of the organic material in process A and process B

	2004	FM	C <sub>tot</sub>	N <sub>org</sub>	N <sub>sol</sub>	N <sub>tot</sub>	NH <sub>4</sub>	NO <sub>x</sub>	K	P
		t d <sup>-1</sup>	kg t <sup>-1</sup> FM	kg t <sup>-1</sup> FM	kg t <sup>-1</sup> FM	kg t <sup>-1</sup> FM	kg t <sup>-1</sup> FM	g t <sup>-1</sup> FM	kg t <sup>-1</sup> FM	kg t <sup>-1</sup> FM
Input manure	Spring	2.0	85	3.68	0.82	4.50	0.67	121	3.90	1.13
	Autumn	2.4	79	2.81	0.69	3.50	0.45	240	4.70	0.68
Output solid fraction	Spring	0.9	125	3.55	0.76	4.30	0.68	61	3.10	0.83
	Autumn	1.2	112	3.07	0.63	3.70	0.44	190	3.90	0.71
Output effluent	Spring	1.0	20	2.10	1.40	3.70	1.20	200	3.40	0.79
	Autumn	1.2	9	1.40	1.10	2.50	1.00	100	3.20	0.51
Compost of solid fraction	Spring	0.4	112	6.29	0.11	6.40	0.06	50	7.25	1.60
	Autumn	0.3	206	13.49	0.41	13.90	0.15	253	15.33	2.83
Compost of manure	Spring	0.9	83	5.17	0.13	5.30	0.06	70	6.80	2.00
	Autumn	0.7	114	8.32	0.41	8.73	0.06	350	15.00	2.47

Finally, we applied equations 30 to 33 to calculate the nutrient losses of both processes. The results for spring are shown in figure 18 and for autumn in figure 19.

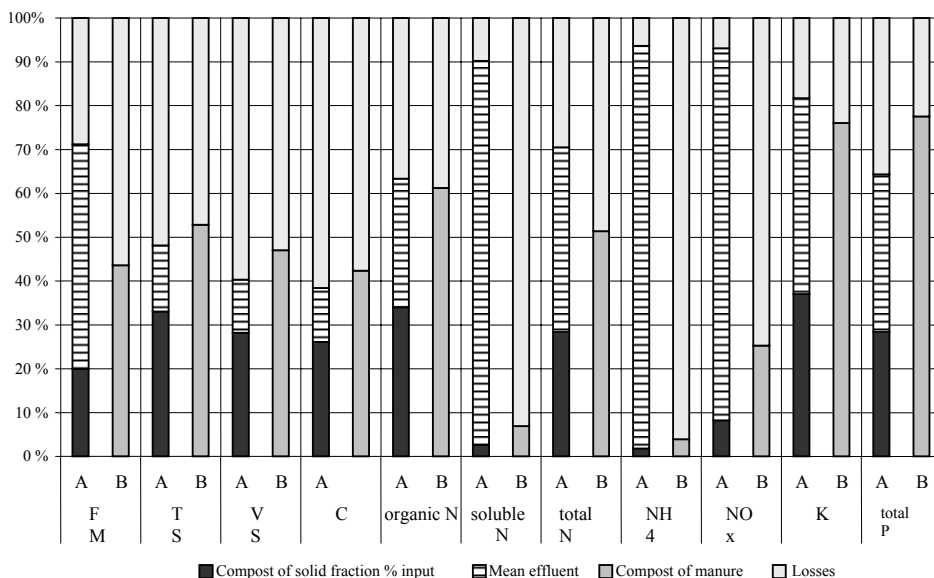

Figure 18. Nutrient balance of the biogas plant versus mere compost, spring 2004. 100% = solid manure input. A: anaerobic process followed by aerobic composting of solid fraction; B: aerobic composting of manure.

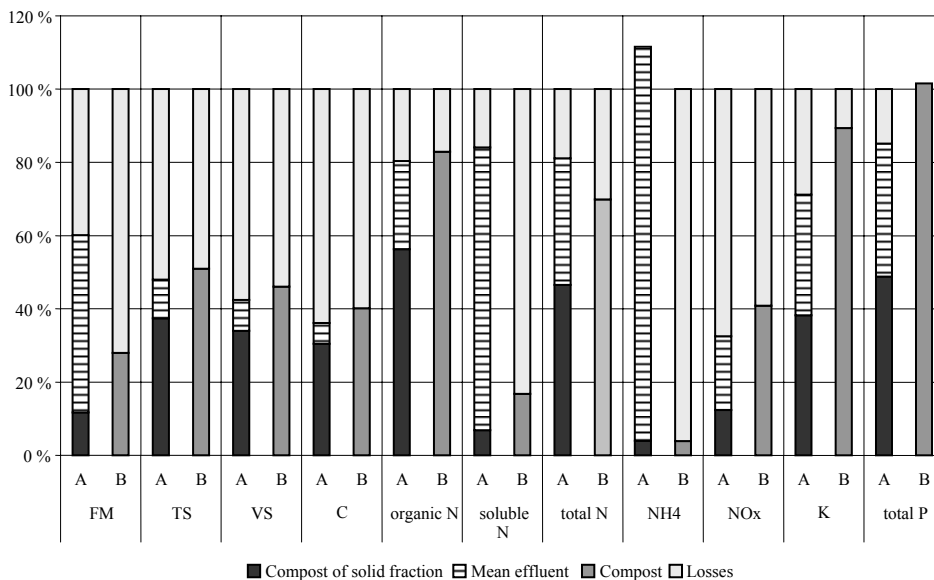

Figure 19. Nutrient balance of the biogas plant versus mere compost, autumn 2004. 100% = solid manure input. A: anaerobic process followed by aerobic composting of solid fraction; B: aerobic composting of manure.

During the anaerobic digestion in process A, 14.6 to 15.4% of the carbon remained in the biogas. During aerobic composting escaped 26 to 31% of the input carbon of the solid fraction. In process B, 58 to 60% of the carbon escaped during aerobic composting. Even if the biogas yield would be threefold more, there would still be 41 to 42.5% carbon available for composting of the solid fraction. This confirms the hypothesis that the anaerobic digestion of manure for biogas production and following aerobic digestion of the solid fraction hardly has a negative impact on the humus balance (Möller 2003) compared to mere aerobic composting.

Total nitrogen losses ranged between 19% and 29% in process A and between 30% and 48% in process B. Similar values we found for  $\text{NH}_4$ : up to 6% losses in process A versus 96% in process B. The results confirm the calculations of Möller (2003) that biogas production increases recycling of  $\text{NH}_4$  and reduces overall nitrogen losses compared to mere aerobic composting. Potassium and phosphorus losses should not occur. However, the calculated losses were higher in process A than process B. The reason may be that the error margin of the laboratory analysis is 10%. Further, the mass balance results may be not precise enough due to the low number of samples.

### **3.1.4 Energy balance**

Produced and consumed energy between 23.11.2003 and 7.5.2004 is shown in figure 20. The mean day temperature was about 0.4 °C. In average 76.3% of produced methane was used for process heating. At most 56% of the produced energy was available for heating the farm estate. The calculated conductive and convective heat losses of the reactors were only 9.5% in contrast to 53.3% heat energy required for heating up the manure and the liquid fraction respectively. The overall heat consumption was 206 kWh d<sup>-1</sup> or 103 kWh t<sup>-1</sup> FM. Additionally 32 kWh d<sup>-1</sup> or 16 kWh t<sup>-1</sup> FM electric power was consumed. These values range above the energy demand of German biogas plants. The most recent biogas plant survey reports 44 to 94 kWh t<sup>-1</sup> FM heat and 0.51 to 51 kWh t<sup>-1</sup> FM electric power (Bundesforschungsanstalt für Landwirtschaft (FAL) 2006). The mean energy efficiency of the whole plant was 24% based on the produced energy and the maximum achieved efficiency was about 49%.

Legrand (1993) calculated a thermal balance for a full size thermophilic biomass reactor at -20°C. The total heat requirement of 5.1% of the total gas production seems very optimistic.

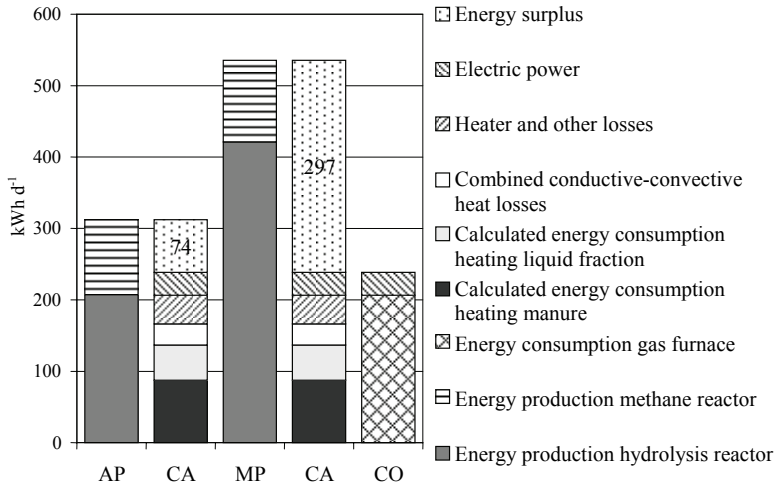

Figure 20. Produced and consumed energy of the biogas plant in Järna between 15.11.2003 and 7.5.2004. AP: average methane production, CA: calculated energy consumption, MP: maximum methane production, CO: recorded energy consumption.

### 3.2 Assessment of decontamination

The impact of the regulation (EC) No 1774/2002 on decontamination of substrates of biogas plants is described in detail by Philipp et al. (2004). National regulations are the environmental impact assessment law (468/1994), the environmental impact assessment decree (268/1999), the environmental protection law (86/2003), the environmental protection decree (169/2000), and the fertiliser manufacture law (71/2005).

During the measuring periods, only material of risk category 3 and oat husk were used. Therefore, no decontamination measures were necessary. For use of food residues, a pasteurisation/decontamination unit is required. This material must be treated before entering the unit at 70°C for 60 minutes at particle size of 12 mm.

Figure 21 shows the effect of aerobic and anaerobic treatment on enterococcus. Enterococcus ranged in manure between  $3.3 \cdot 10^5$  and  $2.5 \cdot 10^7$  colony forming units (cfu)  $g^{-1}$ . After anaerobic digestion, remained in the solid fraction  $2.4 \cdot 10^5$  to  $4.2 \cdot 10^5$  cfu  $g^{-1}$ . After composting the solid fraction we found still  $1.5 \cdot 10^2$  to  $4.4 \cdot 10^5$  cfu  $g^{-1}$ . Aerobic fermentation of manure reduced enterococcus to 50 to 270 cfu  $g^{-1}$ . The results mirror the fact, that temperature during aerobic process is usually higher than within the biogas reactor. Nevertheless, anaerobic digestion improves the hygienic quality of manure too.

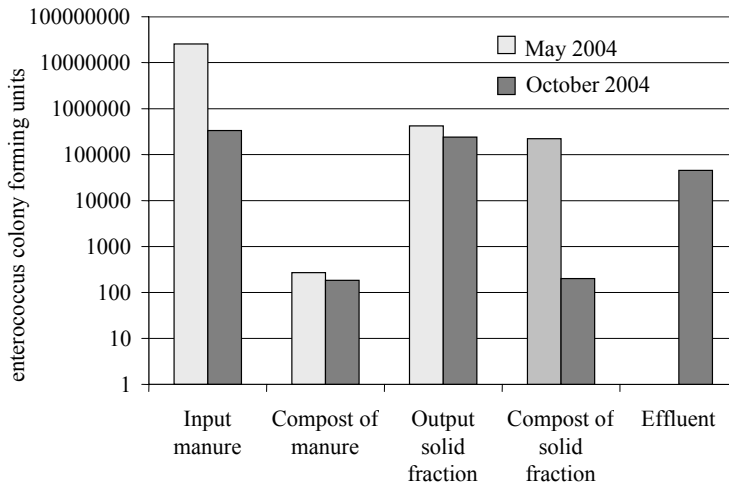

Figure 21. Number of enterococcus colony forming units before and after anaerobic and aerobic fermentation

Figure 22 shows the mean temperature of the organic material during composting. A technical fault of the cooling machine caused the increase of the environmental temperature above 15°C in May 2004. The process of the solid fraction was faster in particular at high dry matter content and the temperature remained above 30°C about one week.

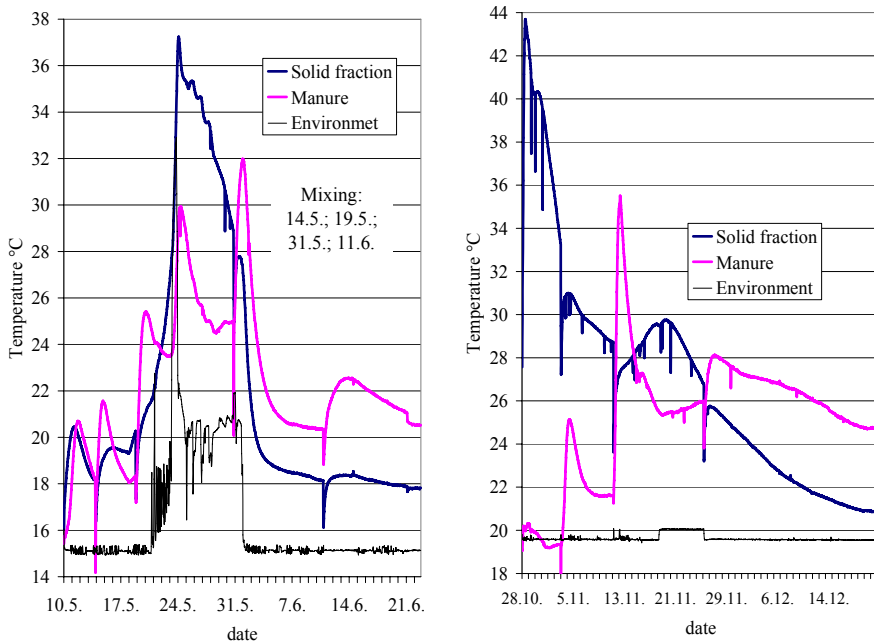

Figure 22. The mean temperature during aerobic fermentation of manure and solid fraction.



The C/N ratio before composting ranged in fresh manure between 19 and 23 and in the solid fraction between 29 and 30. The C/N ratio after composting ranged in fresh manure between 13 and 16 and in the solid fraction between 15 and 17.

### 3.3 Economic assessment

The biogas plant in Järna cost about 200 000 € or 2 800 € m<sup>-3</sup> reactor capacity. According to the survey in Germany investment cost of reactors range usually between 200 and 400 € m<sup>-3</sup> (Bundesforschungsanstalt für Landwirtschaft (FAL) 2006).

The biogas surplus was used for heating the farm estate. The monetary value of saved light fuel oil (6 cent kW<sup>-1</sup>h<sup>-1</sup>) replaced is about 1 600 € a<sup>-1</sup> for average biogas production and about 6 700 € a<sup>-1</sup> for the achieved maximum gas production. Additionally the biogas plant saved about 300 kg N a<sup>-1</sup> or 150-300 € a<sup>-1</sup>.

If the depreciation period lasts 20 years the comparison of the Järna plant with other dry fermentation plants shows that the investment cost are exceeded only by the container module whereas the methane production cost are competitive to other solutions if the plant generates the maximum yield. The most important advantage compared to other solutions is, that the plant works automatically and does not need any work for feeding the reactors.

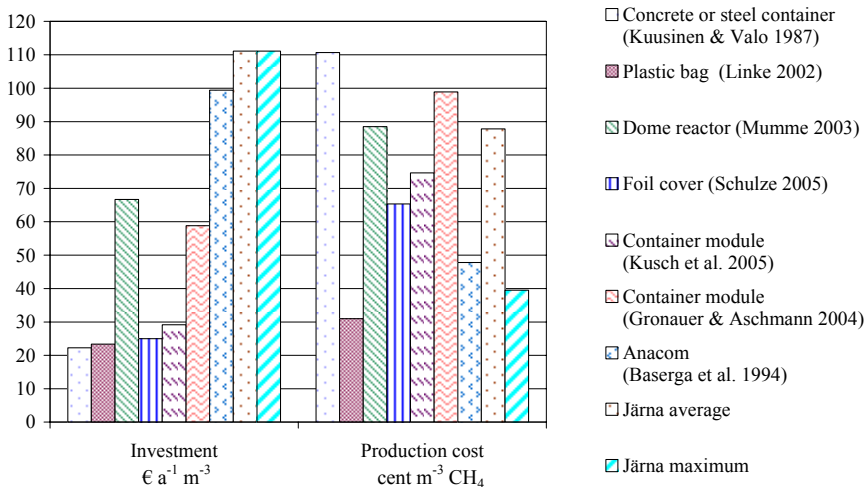

Figure 23. Comparison of investment and production cost of dry fermentation plants with the biogas plant in Järna on average and maximum production level.

### 3.4 Environmental assessment

As shown in the nutrient balance, the reduction of nitrogen losses is the most important advantage of the plant in respect of environmental impact. However, the saving of 300 kg N per year is not enough to justify the high investment cost. An overall assessment of the environmental benefits is difficult. If we apply the findings of Sneath et al. (2006) and assume that 2 m<sup>3</sup> in door manure is produced 240 days per year than the biogas plant reduced the CH<sub>4</sub> emissions by 8.2 kg C a<sup>-1</sup> (2 m<sup>3</sup> d<sup>-1</sup> · 240 d a<sup>-1</sup> · 17.1 g C m<sup>-3</sup> d<sup>-1</sup>) and the nitrous oxide emissions by 197.3 g N (2 m<sup>3</sup> d<sup>-1</sup> · 240 d a<sup>-1</sup> · 411 mg N m<sup>-3</sup> d<sup>-1</sup>). If we apply the findings of Skiba et al. (2006) and assume, that the dung heap for aerobic composting accumulated daily 2 m<sup>3</sup> manure over a period of 300 d a<sup>-1</sup> than the biogas plant reduced the N<sub>2</sub>O-N emissions by 126 to 3474 kg N<sub>2</sub>O-N a<sup>-1</sup> (300 m<sup>3</sup> a<sup>-1</sup> · 300 d a<sup>-1</sup> · 1.4 to 38.6 g N<sub>2</sub>O-N m<sup>-3</sup> d<sup>-1</sup>). However, these figures do not take into consideration, that the compost of the solid fraction may cause emissions too. On the other hand, the high dry matter content of the solid fraction allows to set up higher compost heaps, facilitating high temperatures and a low surface area to volume ratio.

An ideal environmental assessment should include the whole farm organism. We present here a raw estimation of the nutrient flow based on the data we got from the farmer. This draft includes only the nitrogen and phosphorus balance during the winter period. The figures of N and P concerning the biogas plant base on the mean values of our measurements in May and October 2004, see appendix 7.4.

The nutrient circuit of process A is described in figure 24, see numbers 1 to 10.

1. We assume the mean value of nitrogen and phosphorus in manure measured in May and October 2004. The manure is fed into the biogas plant. We observed losses of both nitrogen and phosphorus. The phosphorus losses may be explained by uncertainty in measurement.
2. The solid fraction is composted. During composting, we observed nitrogen losses.
3. The urine, the effluent, and the composted solid fraction are spread on the fields of the farm (135 ha).
4. The fields produce green fodder, hay and silage (89 ha), winter wheat (26 ha) and oats (20 ha). Cereals are used as feed too. Straw and husk from the harvested cereals are used as litter.
5. We assume that 6 kg ha<sup>-1</sup> a<sup>-1</sup> organic phosphorus fertilizer is applied. This corresponds to 2.2 kg P d<sup>-1</sup>.

6. We assume that all nutrients are taken up by the field crops and the yield is used for fodder.
7. Biological N-fixation on the green land and pasture generates additional nitrogen on the field. We assume  $50 \text{ kg ha}^{-1} \text{ a}^{-1}$  (Grönroos and Seppälä 2000).
8. The dairy cattle use the fodder for meat and milk production.
9. Milk and meat remove nitrogen and phosphorus from the farm. We apply figures of (Grönroos and Seppälä 2000).
10. The difference between the nutrients in fodder and the removals by milk, meat, and excretions results in a surplus.

The nutrient circuit of process B is described in figure 25 using the same assumptions as in process A. Because the losses of aerobic manure compost are higher, the nutrient surplus is smaller compared to process A.

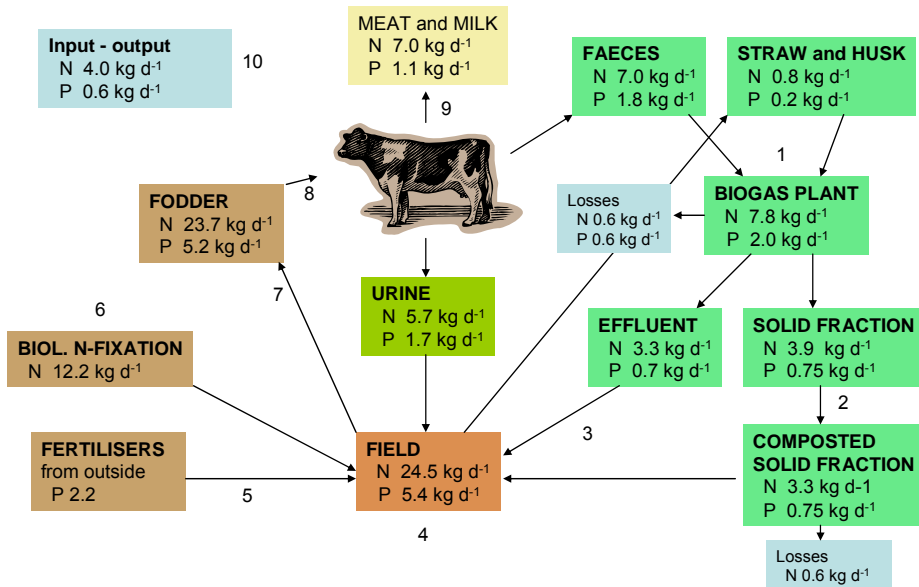

Figure 24. Nitrogen and phosphorus balance of process A for 55 LU.

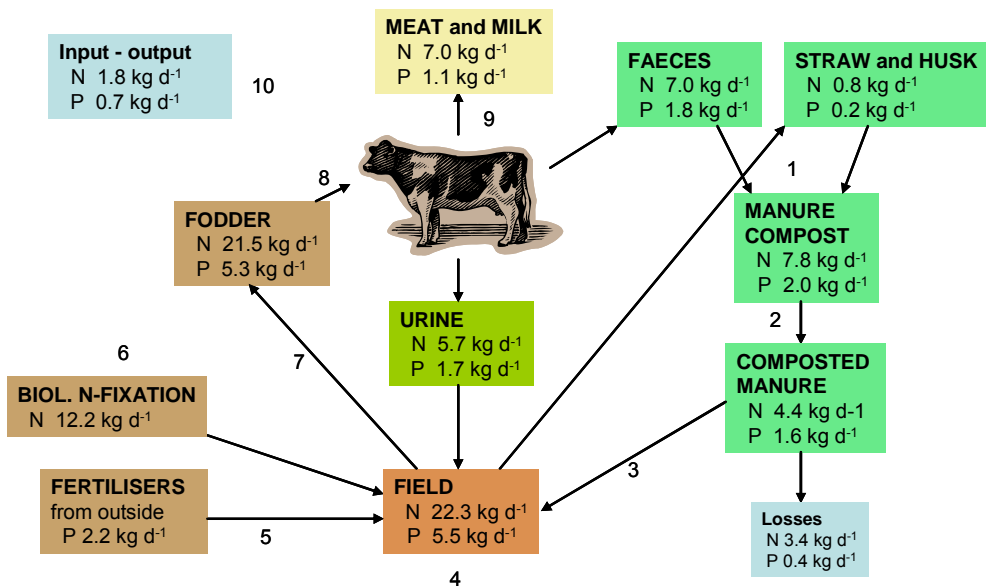

Figure 25. Nitrogen and phosphorus balance of process B for 55 LU.

## 4 Discussion

Dry fermentation technology up to now does not offer competitive advantages in biogas production compared to slurry based technology as far as only energy production is concerned. However, the results give an overview of existing technical solutions of farm-scale dry fermentation plants. The results also show that the ideal technical solution is not invented yet. This may be a challenge for farmers and entrepreneurs interested in planning and developing future dry fermentation biogas plants on-farm. Development of new dry fermentation prototype plants requires appropriate compensation for environmental benefits like closed energy and nutrient circles to improve the economy of biogas production. The prototype in Järna meets the objectives of the project since beside energy a new compost product from the solid fraction was generated. On the other hand the two-phase process consumes much energy and the investment costs are high ( $>2000 \text{ € m}^{-3}$  reactor volume).

We did not find any refereed scientific paper that includes a documentation of an on-farm dry fermentation biogas plant. It seems that we tried first. We also could not find any results about the biogas potential of oat husks, so we may have found these results first.

Farm scale production of anaerobically treated solid manure for composting is new. Dry fermentation biogas plants offer the possibility to design solid manure compost by variation of fermentation process parameters.

### 4.1 Conclusions for farmers

Anaerobic dry fermentation on-farm technology is not yet competitive. Pioneer farmers, who want to try this technology, should follow up these steps:

- Estimate the quantity of organic matter and the availability during the year.
- Measure dry matter content and organic dry matter content of the organic matter.
- Review literature for the biogas potential of similar organic material. Even exotic mixtures of organic material can be found. E.g., a mixture of wood chips and potato waste inoculated with cattle slurry generated within 30 days 250 l biogas  $\text{kg}^{-1}$  TS at 35°C (Schelle & Linke 1995).
- Analyse the biogas potential of the organic matter you want to digest in case there are no data available. This can be done in laboratories e.g. at the University of Jyväskylä or at the University of Stuttgart

Hohenheim (Helffrich & Oechsner 2003) or in a small self-made laboratory reactor.

- Look at existing plants most suitable for your farm and your conditions and choose the appropriate type or develop a better prototype.
- Estimate or analyse the process heat required.
- Calculate the potential income according to table 6.
- Estimate whether the potential income covers depreciation, operating, and work costs.
- If you still want to continue, search for assistance (research and/or advisory services) to plan and set up your prototype as a research and development project and look for funding agencies.

## **4.2 Conclusions for biogas plant manufacturers**

Farmers need both, continuous and batch processing biogas plants. Latter ones are suitable for deep litter housing systems. The ideal dry fermentation plant on farm fulfils following criteria:

- Automatic feeding and discharging
- Digestion of high dry matter content.
- Low process energy
- Low retention time
- Competitive investment costs

The successful biogas plant manufacturer will:

- Invent a prototype that is cheaper than the plants described in this paper.
- Search for farmers ready to co-operate.
- Follow the steps described under 4.1.

Ideas for improvements you get from experienced scientists working since decades on biogas technology. The most important institutes in the world are mentioned in the following chapter. As an example of a new approach to improve dry fermentation technique we want to draw your attention to rotational drum fermentation systems (Jiang et al. 2002, 2003, and 2005).

### 4.3 Conclusions for decision makers

From different scientific publication databases we found about 10 000 references concerning biogas research during the past 10 years. Less than ten are dealing with biogas reactors for non-liquid substrates on-farm. Recent research mainly concentrates on basic research, biogas process research for communal waste, large-scale biogas plants, and research on laboratory level. This mirrors the fact, that production of research papers is rather financed than product development on site.

The literature review revealed that progress in biogas research related to agriculture is focused on several institutions and persons. We list frequently cited names throughout our review in table 12. This table is not necessarily complete. An excellent overview about biogas research institutes and research workers is given by Marchaim (1992).

Another observation is that technical progress first takes place on-farm. This means that farmers, constructors, and enterprises working on biogas plants are often the driving force in developing new technologies or technical solutions. The biogas plant in Järna is a typical example of this approach too. As a following, there is a gap between progress in research findings and progress in biogas technology on-farm. Usually the pilot plants are not documented by scientists, or the documentation is rather published in non-public reports than in scientific journals.

Our conclusion is that it seems worldwide to be very difficult or even impossible to find financial support for on site research, especially for on-farm prototype biogas reactors. We suppose the following reasons for this fact: biogas plant research requires proficiency in many different scientific disciplines, lack of co-operation between engineering and life sciences, high development costs to transfer basic research results into practical technical solutions, low interest of researchers because on site and on-farm research enjoys low appreciation in terms of scientific credits, portability of farm specific design and process management is difficult.

Based on these findings, we recommend the following measures to improve co-operation between funding agencies, farmers, and entrepreneurs':

- On-site and on-farm research using a “radical holistic research strategy” (Baars 2002) has to be supported by funding agencies if integration of biogas and bio energy into the farm organism is considered as an important target within the agriculture policy framework.
- Public subsidies for developing prototype plants should include the obligation to scientific documentation and monitoring. Thus, scientific monitoring of existing biogas plants in Finland is necessary to

assess the biogas production costs and the long-term environmental impact. Oechsner et al. (1998), Gronauer & Aschmann (2004), and Bundesforschungsanstalt für Landwirtschaft (2006) present excellent examples.

- Long-term research is necessary. E.g., the dry fermentation pilot plant established at the Labby farm run only one year (Kuusinen & Valo, 1987). Despite of considerable public investments the results did not meet the expectations and the operation of the plant seemed to be unprofitable. Steady improvement in co-operation between scientists and the farmer over decades would have given the chance to develop the leading dry fermentation technology today. This report may be the basis for long-term improvement and optimisation of the prototype plant in Järna.
- A competence centre for on-farm biogas plants should be established in Finland. The centre could be located at a university. It should embrace scientists from engineering, agriculture, and environmental sciences.



Table 12: Institutions and key persons in biogas research related to agriculture

Country	Institute	Key person
Finland	University of Jyväskylä, Department of Biological and Environmental Science <a href="http://www.jyu.fi/science/laitokset/bioenv/en/">http://www.jyu.fi/science/laitokset/bioenv/en/</a>	Prof. Jukka Rintala
Sweden	Swedish Institute of Agricultural Engineering, UPPSALA <a href="http://www.jti.slu.se/jtieng/jtibrief.htm">http://www.jti.slu.se/jtieng/jtibrief.htm</a>	Dr. Åke Nordberg
Germany	Leibniz-Institute of Agricultural Engineering Bornim ATB (reg. Assoc.) <a href="http://www.atb-potsdam.de/">www.atb-potsdam.de/</a>	Dr. habil. Bernd Linke
Germany	Bavarian State Research Center for Agriculture, Institute for Agricultural Engineering, Farm Buildings and Environmental Technology, Freising-Weihenstephan <a href="http://www.lfl.bayern.de/ilt/">http://www.lfl.bayern.de/ilt/</a>	Dr. Andreas Gronauer Dr. Heinz Schulz†
Germany	Federal Agricultural Research Centre FAL, Institute of Technology and Biosystems Engineering <a href="http://www.tb.fal.de/en/index.htm">http://www.tb.fal.de/en/index.htm</a>	Prof. Peter Weiland Prof. Batel†
Germany	University of Hohenheim, The State Institute of Farm Machinery and Farm Structures (reg. Assoc.) <a href="http://www.uni-hohenheim.de/i3ve/00000700/00390041.htm">http://www.uni-hohenheim.de/i3ve/00000700/00390041.htm</a>	Dr. Hans Oechsner
Austria	University of Natural Resources and Applied Life Sciences, Vienna (BOKU), Department f. Nachhaltige Agrarsysteme <a href="http://www.boku.ac.at/">http://www.boku.ac.at/</a>	Prof. Thomas Amon
Austria	University of Natural Resources and Applied Life Sciences, Vienna (BOKU), Umweltbiotechnologie <a href="http://www.boku.ac.at/">http://www.boku.ac.at/</a>	Prof. Rudolf Braun
Netherlands	Wageningen University & Research Centre, Agrotechnology & Food Innovations <a href="http://www.afsg.wur.nl/NL/">http://www.afsg.wur.nl/NL/</a>	
Israel	Migal Galilee Technology Center <a href="http://www.migal.org.il">www.migal.org.il</a>	Prof. Uri Marchaim
USA	College of Tropical Agriculture and Human Resources, University of Hawaii At Manoa <a href="http://www.ctahr.hawaii.edu/acad/Admin/Dean/DeansCV.html">http://www.ctahr.hawaii.edu/acad/Admin/Dean/DeansCV.html</a>	Prof. Andrew G. Hashimoto

## 5 Summary

Chapter 1 of this feasibility study describes the farm scale dry fermentation prototype biogas plants developed up to now based on a literature review and visits at several plants. There is only one manufacturer offering farm scale dry fermentation plants. The present technical development shows that slurry biogas plants are improved to digest organic material of high dry matter content too. This is because digestion of energy crops (NAWARO = nachwachsende Rohstoffe) is supported at least in Germany. However, farmers using a solid manure chain or deep litter housing still cannot compete with farmers using the slurry technology if they want to produce biogas from manure.

Chapter 2 describes the methods used in this feasibility study for documentation, sampling, analysis, and modelling. Additionally we developed a new calculation method for the mass balance. By this method, we may save expensive measuring costs of high volume mass flow of organic material. The description of this method is subject of a future publication.

Chapter 3 presents the documentation and measuring results of the prototype biogas plant in Järna. The plant is the first farm scale plant digesting fully automatically solid manure. It is also the first plant where a solid fraction is separated after the hydrolysis and before the methanisation phase. We present first time a complete mass, nutrient and energy balance of a continuously working solid manure biogas plant.

In chapter 4, we conclude that long-term research and development on dry fermentation on-farm is necessary. A more holistic approach is recommended because the economical assessment of on-farm biogas plants should always include the whole farm organism.

## 6 References

- Asmus, F. & Linke, B. 1987. Zur pflanzenbaulichen Verwertung von Gülle-Faulschlamm aus der Biogasgewinnung. *Feldwirtschaft* 28: 354-355.
- Asmus, F. Linke, B. & Dunkel, H. 1988. Eigenschaften und Düngerwirkung von ausgefauter Gülle aus der Biogasgewinnung. *Arch. Acker- Pflanzenbau Bodenkd* 8: 527-532.
- Baars, T. 2002. Reconciling scientific approaches for organic farming research. Ph.D. Thesis, Louis Bolk Institute, Driebergen, Netherlands. 345p. ISBN 90-74021-25-5.
- Baserga, U., Egger, K. & Wellinger, A. 1994. Biogas aus Festmist. Entwicklung einer kontinuierlich betriebenen Biogasanlage zur Vergärung von strohreichem Mist. FAT-Berichte Nr. 451. Tänikon: Eidgenössische Forschungsanstalt für Agrarwirtschaft und Landtechnik (FAT) Tänikon. 12 p.
- Baserga, U., & Egger, K. 1994. Entwicklung der Gärkanal-Pilotanlage zum Vergären von strohhaltigem Mist. NovaEnergie, CH-8356 Ettenhausen. <http://www.biogas.ch/f+e/kanalbas.htm>
- van Benthem, H. & Hänninen, K. 2001. Lannan anaerobiprosessin ympäristövaikutuksista Vakka-Suomen alueella. Jyväskylän yliopisto. 9 p.
- Boxberger, J., Amon, Th., & Weber, A. 2002. Biogasnutzung im Kontext von Agrar-, Umwelt- und Energiepolitik. In: Fachverband Biogas e.V (ed.). Berichte zur 11. Jahrestagung des Fachverbandes Biogas e.V. in Borken. Tagungsbericht 2002: Biogas – die universelle Energie von morgen. Jahrestagung des Fachverbandes Biogas e.V., Borken bei Kassel, 29.-31.01.2002. Freising: Fachverband Biogas e.V. p. 7-13.
- Braun, R., Madlener, R. & Laaber, M. 2005. Efficiency evaluation of energy crop digestion plants. In: Åke Nordberg (Ed.). The future of biogas for sustainable energy production in Europe, 7<sup>th</sup> FAO/SREN-workshop, Uppsala, 30. November – 2. December 2005. Uppsala: JTI.
- Brockmann, H.-J. 1987. Taschenbuch für den Maschinenbau / Dubbel. Beitz, W. & Küttner, K.-H. (Eds.). 16. korrigierte u. erg. Aufl. Berlin ISBN 3-540-18009-5.
- ten Brummeler, E. 2000. Full scale experience with the BIOCEL process. *Water Sciences and Technology* 41: 299-304.
- Bundesforschungsanstalt für Landwirtschaft (FAL) Institut für Technologie und Biosystemtechnik 2006. In: Fachagentur Nachwachsende Rohstoffe e.V. (FNR) (Ed.). Ergebnisse des Biogas-Messprogramms. Gülzow: FNR. 163 p.

- Deuker, A., Möller, K. & Leithold, G. 2005. Comparison of system effects from fermented and unfermented organic fertilizers and fermentation of vegetal by-products on plant production in an organic farming system with husbandry. In: Heß, J. & Rahmann, G. (Eds.). Ende der Nische, Beiträge zur 8. Wissenschaftstagung Ökologischer Landbau. Ende der Nische, Kassel, 1.3.2005 - 4.3.2005. Kassel: Kassel university press GmbH. p. 237-240.
- EEA (European Environment Agency) 2004. EMEP/CORINAIR Emission Inventory Guidebook – 2004. Technical report No 30. Manure management regarding Nitrogen compounds. 41 p. Publish date: 2004/01/19.  
<http://reports.eea.eu.int/EMEP/CORINAIR4/en/B1090vs2.pdf>
- European Commission, Directorate-General for Agriculture 2003. CAP reform summary. Newsletter Special Edition, 20 July 2003, 8 p.  
[http://europa.eu.int/comm/agriculture/mtr/index\\_en.htm](http://europa.eu.int/comm/agriculture/mtr/index_en.htm)
- Fischer, T., Rilling, N. & Stegmann R. 1994. Das ATF-Verfahren der Technischen Universität Hamburg-Harburg (The ATF-Process of the Technical University of Hamburg-Harburg). In: Märkl, H. & Stegmann, R. (Eds.). Anaerobe Behandlung von festen und flüssigen Rückständen, Beiträge zu einer Veranstaltung des Sonderforschungsbereiches 238 der Deutschen Forschungsgemeinschaft in Zusammenarbeit mit der DECHEMA-Fachsektion Biotechnologie, Hamburg, 2. - 4. November 1994. DECHEMA Monographien, Vol. 130. Weinheim, Basel (Switzerland), New York, Cambridge: VCH. p. 287-290. ISBN: 3527102248.
- Garrison, M. & Richard. T. 2005. Methane and Manure: Feasibility Analysis of Price and Policy Alternatives. Transactions of ASAE 48: 1287-1294.
- Granstedt, A. 2003. Baltic Ecological Recycling Agriculture and Society (BERAS). Järna, Sweden: The Biodynamic Research Institute Skilleby. 9 p. <http://www.jdb.se/beras/>
- Gronauer, A. & Aschmann, V. 2004. Wissenschaftliche Begleitung einer Pilotanlage zur Feststoffvergärung von landwirtschaftlichen Gütern. Gelbes Heft Nr. 77 des Bayerischen Staatsministeriums für Landwirtschaft und Forsten in München. 140 p.
- Grönroos, J. & Seppälä, J. (eds.) 2000. Maatalouden tuotantotavat ja ympäristö. Suomen ympäristö 431. Helsinki: Suomen ympäristökeskus. 244 p.
- Gruber, L. & Steinwider, A. 1996. Influence of nutrition on nitrogen and phosphorus excretion of livestock – Model calculations on the basis of a literature review. Die Bodenkultur 47: 255-277.
- Hagström, M., Vatiainen, E. & Vanhanen, J. 2005. Biokaasun maatilatuotannon kannattavuusselvitys. Maa- ja metsätalousministeriö, Helsinki. Julkaisematon loppuraportti 77 p.

- Hashimoto, A. 1986. Pretreatment of wheat straw for fermentation to methane. *Biotechnology and Bioengineering*, 28: 1857-1866.
- Helfrich, D. & Oechsner, H. 2003. Hohenheimer Biogasertragstest. Vergleich verschiedener Laborverfahren zur Vergärung von Biomasse. *Landtechnik* 3: 148-149.
- Hill, D.T. 1984. Methane productivity of the major animal waste types. *Transactions of the ASAE*: 530-534.
- Hofenk, G., Lips, S.J.J., Rijkens, B.A. & Voetberg, J.W. 1984. Two phase anaerobic digestion of solid organic wastes yielding biogas and compost. (Final report. EC Contract no.: ESE-E-R-040-NL). Instituut voor Bewaring en Verwerking van Landbouwprodukten - IBVL Wageningen. Report 510. 57 p.
- Hoffmann, M. & Lutz, P. 2000. Trockenfermentation. Innovation in der Biogastechnologie. Fachbeiträge zur gemeinsamen Fachtagung der Regierung von Niederbayern und der Fachhochschule Deggendorf am Mittwoch, 13. Dezember 2000 an der Fachhochschule Deggendorf. <http://www.regierung.niederbayern.bayern.de/wirfuersie/biogas/Hoffman01.pdf>
- Hoffmann, M. 2000. Fermentation of stacked solid matter. *Landtechnik* 55: 442-443.
- Hoffmann, M. 2001. Dry fermentation: development status and prospects. *Landtechnik* 56: 410-411.
- Hänninen, K., Rintala, J. & Kettunen, R., 2001. Jätteiden käsittelylaitokset ja kaatopaikat. Luentomoniste 12.4.2001. Jyväskylä: Jyväskylän yliopisto, Bio- ja ympäristötieteiden laitos. 124 p.
- IFOAM 2002. IFOAM Basic Standards of Organic Agriculture and Food Processing. <http://www.ifoam.org/standard/basics.html>
- Jäkel, K. 2004 Wirtschaftlichkeit der Trockenfermentation. In: Fachagentur Nachwachsende Rohstoffe e.V. (FNR) (Ed.). *Gülzower Fachgespräche* 23. Gülzower Fachgespräch „Trockenfermentation“, Gülzow, 4./5. Februar 2004. Gülzow: FNR. p. 49-61.
- Jiang, W.Z., Kitamura, Y., Ishizuka, N. & Shiina, T. 2002. A rotational drum fermentation system for dry methane fermentation (2). Effect of hydraulic retention time (HRT) and stirring media in fermentor on acidogenic process. *Journal of the Society of Agricultural Structures, Japan* 33: 189–196.
- Jiang, W.Z., Kitamura, Y., Ishizuka, N., Shiina, T., 2003. A rotational drum fermentation system for dry methane fermentation (3): Effect of process configuration on acidogenic process. *Journal of the Society of Agricultural Structures, Japan* 34: 91–100.

- Jiang, W.Z., Kitamura, Y. & Li, B. 2005. Improving acidogenic performance in anaerobic degradation of solid organic waste using a rotational drum fermentation system. *Bioresource Technology* 96: 1537-1543.
- Koriath, H., Herrmann, V., Vollmer, G. & Franz, J. 1985. Nährstoffdynamik während der anaeroben Fermentation von Gülle und Wirkung auf den Ertrag und Inhaltsstoffe von Mais im Gefäßversuch. *Arch. Acker- Pflanzenb. Bodenkd.* 12: 741-747.
- Kraft, E. 2004. Trockenfermentation – Brücke zwischen Abfallbehandlung und Landwirtschaft? In: Fachagentur Nachwachsende Rohstoffe e.V. (FNR) (Ed.). *Gülzower Fachgespräche* 23. Gülzower Fachgespräch „Trockenfermentation“, Gülzow, 4./5. Februar 2004. Gülzow: FNR. p. 81-95.
- Kusch, S. & Oechsner, H. 2004. Feststoffvergärung in Batchreaktoren – erste Versuchsergebnisse. In: Internationales Biogas und Bioenergie Kompetenzzentrum, Fachgruppe Biogas (Eds.). *Tagungsband zur 13. Jahrestagung „Biogas und Bioenergie in der Landwirtschaft“* 2.-4. Dezember 2004 in Wolpertshausen. *Biogas und Bioenergie in der Landwirtschaft, Wolpertshausen, 2.-4. December 2004*. Kirchberg/Jagst: Internationales Biogas und Bioenergie Kompetenzzentrum. p. 115-124.
- Kusch, S., Oechsner, H. & Jungbluth, T. 2005. Vergärung landwirtschaftlicher Substrate in diskontinuierlichen Feststofffermentern. *Agrartechnische Forschung* 11:, 81-91.
- Kuusinen, K. Valo, R. 1987. *Maatalousjätteiden kuivafermentaatio*. Loppuraportti DN-BIOPROCESSING OY, Helsinki. 37 p.
- Lehtimäki, M.: 1995, *Centralised Biogas Plant in Southern Ostrobothnia. Report on Environmental Impacts, Power Production and Financial Preconditions*. Mimeograph Series of the National Board of Waters and the Environment no 625. Helsinki: National Board of Waters and the Environment. 89 p.
- Legrand, R. 1993. Methane from Biomass Systems Analysis and CO<sub>2</sub> Abatement Potential. *Biomass and Bioenergy* 5: 301-316.
- Linke, B. 2004. Substrateinsatz bei der Trockenfermentation – Einschätzung des F+E-Bedarfs. In: Fachagentur Nachwachsende Rohstoffe e.V. (FNR) (Ed.). *Gülzower Fachgespräche* 23. Gülzower Fachgespräch „Trockenfermentation“, Gülzow, 4./5. Februar 2004. Gülzow: FNR. p. 35-48.
- Linke, B., Heiermann, M. Grundmann, P. & Hertwig, F. 2003. Grundlagen, Verfahren und Potenzial der Biogasgewinnung im Land Brandenburg. In: Ministerium für Landwirtschaft, Umweltschutz und Raumordnung des Landes Brandenburg, Referat Presse- und Öffentlichkeitsarbeit (Ed.). *Biogas in der Landwirtschaft. Leitfaden für Landwirte und Investoren im Land Brandenburg*. Potsdam: Ministerium für Landwirtschaft, Umweltschutz und Raumordnung des Landes Brandenburg. p. 10-23.

- Linke, B., Miersch, S. & Gegner, M. 2002. Trockenvergärung im Siloschlauch. In: Fachverband Biogas e.V. (ed.). Berichte zur 11. Jahrestagung des Fachverbandes Biogas e.V. in Borken. Tagungsbericht 2002: Biogas – die universelle Energie von morgen. Jahrestagung des Fachverbandes Biogas e.V., Borken bei Kassel, 29.-31.01.2002. Freising: Fachverband Biogas e.V. p. 70-80. <http://www.biogas.org>.
- Lo, K., Liao, P., Bulley, N. & Chieng, S. 1984. A comparison of biogas production from dairy manure filtrate using conventional and fixed-film reactors. *Canadian Agricultural Engineering* 26: 73-78.
- Loock, R., Fetsch, S. Foellmer, T. & Nödldeke, P. 1999. Trockenfermentation von Restmüll. *Müll und Abfall* 2: 86-90.
- Mäder, P., Fliessbach, A., Dubois, D., Gunst, L., Fried, P. & Niggli, U. 2002. Soil Fertility and Biodiversity in Organic Farming. *Science* 296: 1694-1697.
- Marchaim, Uri, 1992. Biogas processes for sustainable development. FAO Agricultural Services Bulletin No. 95. Rome: FAO. 232 p, ISBN 92-5-103126-6.
- Möller, K. 2003. Systemwirkungen einer "Biogaswirtschaft" im ökologischen Landbau: Pflanzenbauliche Aspekte, Auswirkungen auf den N-Haushalt und auf die Spurengasemissionen. *Biogas Journal* 1: 20-29.
- Møller, H., Sommer, S. & Ahring, B. 2004. Methane productivity of manure, straw and solid fractions of manure. *Biomass & Bioenergy* 26: 485-495.
- Mumme, J. 2003. Trockenfermentation in einer kleintechnischen Batch-Anlage. *Landtechnik* 58: 330.
- Oechsner, H., Weckemann, D. & Buchenau, C. 1998. Biogasanlagen in Baden-Württemberg. *Landtechnik* 1: 20-21.
- Parker, D. 2000. Demonstration of biogas production using low moisture content beef cattle manure. West Texas A&M University, Canyon. [www.westbioenergy.org/cattle/index.htm](http://www.westbioenergy.org/cattle/index.htm)
- Philipp, W., Helm, M., Schneichel, H. Klages, S. Marciniszyn, E., Lorenz, H., Ade-Kappellmann, K. & Döhler, H. 2004. Anforderungen an die Hygienisierung von Substraten. In: Kuratorium für Technik und Bauwesen in der Landwirtschaft e.v.(KTBL). Die Landwirtschaft als Energieerzeuger. KTBL-Schrift 420. Münster: KTBL-Schriften-Vertrieb im Landwirtschaftsverlag GmbH. p. 88-100. ISBN 3-7843-2161-3
- Reeh, U. & Møller, J. 2001. Evaluation of different biological waste treatment strategies. In: Jakob Magid et al. (eds.). Urban areas - rural areas and recycling: the organic way forward. DARCOF Report 3: 51-58. NJF seminar

- NO. 327. Royal Veterinary and Agricultural University, Copenhagen, Denmark, 20–21 August 2001. 10p.  
[http://orgprints.org/198/01/Evaluation\\_\\_UR.pdf](http://orgprints.org/198/01/Evaluation__UR.pdf)
- Rintala, J., Lamoinen, A., Luostarinen, S. Lehtomäki, A. 2002. Biokaasusta uusiutuvaa energiaa maataloilla. Jyväskylä: Jyväskylän yliopisto, Ympäristötieteet, bio- ja ympäristötieteiden laitos. 55 p.  
<http://www.cc.jyu/~ala/biokaasukirjanen.pdf>.
- Schäfer, W. 2003. Biogas on-farm. Energy and material flow. Proceedings of the NJF's 22nd congress 'Nordic Agriculture in Global Perspective', July 1-4, 2003, Turku, Finland. Oiva Niemeläinen and Mari Topi-Hulmi (eds.) July 1-4 2003, Turku, Finland. Jokioinen: MTT Agrifood Research Finland, NJF. <http://orgprints.org/00001299/>
- Schauss, K., Ratering, S. & Schnell, S. 2005. Impact of fermented organic fertilizers on trace gas emissions in organic agriculture. In: Heß, J. & Rahmann, G. (Eds.). Ende der Nische, Beiträge zur 8. Wissenschaftstagung Ökologischer Landbau. Ende der Nische, Kassel, 1.3.2005 - 4.3.2005. Kassel: Kassel university press GmbH. p. 589-592.
- Schelle, H. & Linke, B. 1995. Biogas aus Reststoffen. Landtechnik 3: 160-161.
- Schulze, A. 2005. Dry-fermentation of farmyard manure and maize silage in foil covered heaps. Seminar "Dry fermentation on-farm". Olkkala estate 14.2.2005. Vihti: MTT Agricultural Engineering Research (Vakola).
- Schwarz, M. 2004 Gastrennung mittels Membrantrennverfahren. - Untersuchung der Verwendung von Polyimidmembranen bei Erdgas und Biogas". Begutachter: A. Friedl, M. Harasek; Institut für Verfahrenstechnik, Umwelttechnik und Technische Biowissenschaften Technische Universität Wien.  
<http://www.vt.tuwien.ac.at/savt/pdf/04-2/15-20%20Diss%20Schwarz.pdf>
- SFS-EN ISO 10628:en 2000. Flow diagrams for process plants. General rules. Helsinki: Suomen Standardisoimisliitto SFS ry. 59 p.
- Skiba, U., DiMarco, C., Hargreaves, K., Sneath, R. & McCartney, L. 2006. Nitrous oxide emissions from a dung heap measured by chambers and plume methods. Agriculture, Ecosystems and Environment 112: 135-139.
- Sneath, R. Beline, F. Hilhorst, M. & Peu, P. 2006. Monitoring GHG from manure stores on organic and conventional dairy farms. Agriculture, Ecosystems and Environment 112: 122-128.
- Tiquia, S., Richard, T. & Honeyman, M. 2002. Carbon, nutrient, and mass loss during composting. Nutrient Cycling in Agroecosystems 62: 15-24.
- VNa 931/2000. Valtioneuvoston asetus maataloudesta peräisin olevien nitraattien vesiin pääsyn rajoittamisesta, annettu Helsingissä 9.11.2000.



VNp 861/1997. Valtioneuvoston päätös kaatopaikoista, annettu Helsingissä 4.9.1997.

Weiland, P. 2003. Notwendigkeit der Biogasaufbereitung und Stand der Technik. In: Fachagentur für Nachwachsende Rohstoffe e.V. (FNR) (Ed.). Gülzower Fachgespräche Bd. 21. Workshop „Aufbereitung von Biogas“, FAL Braunschweig, 17./18. Juni 2003. Gülzow: FNR. p. 23-35.

Weiland, P. & Rieger Ch. 2005. Experience report from the evaluation of 60 agricultural biogas plants in Germany. In: Åke Nordberg (Ed.). The future of biogas for sustainable energy production in Europe, 7<sup>th</sup> FAO/SREN-workshop, Uppsala, 30. November – 2. December 2005. Uppsala: JTI.

Wulf, S., Jäger, P. & Döhler, H. 2005. Balancing of greenhouse gas emissions and economic efficiency for biogas-production through anaerobic co-fermentation of slurry with organic waste. *Agriculture Ecosystems & Environment* 112: 178-185.

Yamulki, S. 2006. Effect of straw addition on nitrous oxide and methane emissions from stored farmyard manures. *Agriculture, Ecosystems & Environment*, 112: 140-145.

# 7 Appendices

## Appendix 1. Kuvailulehti

Julkaisija  
MTT Agrifood Reserach Finland

KUVAILULEHTI

Julkaisun päivämäärä  
14.3.2006

Tekijät (toimielimistä; toimielimen nimi, puheenjohtaja, sihteeri Winfried Schäfer, Marja Lehto, Frederick Teye		Julkaisun nimi Dry anaerobic digestion of organic residues on-farm - a feasibility study	
		Toimeksiantaja	
		Toimielimen asettamispäivämäärä	
Julkaisun nimi Dry anaerobic digestion of organic residues on-farm - a feasibility study Kuivamädätys maatalan jätteiden käsittelyssä			
Tiivistelmä Chapter 1 of this feasibility study describes the farm scale dry fermentation prototype biogas plants developed up to now based on a literature review and visits at several plants. There is only one manufacturer offering farm scale dry fermentation plants. The present technical development shows that slurry biogas plants are improved to digest organic material of high dry matter con-tent too. This is because digestion of energy crops (NAWARO= nach-wachsende Rohstoffe) is supported at least in Germany. However, farmers using a solid manure chain or deep litter housing still cannot compete with farmers using the slurry technology if they want to produce biogas from manure. Chapter 2 describes the methods used in this feasibility study for documentation, sampling, analysis, and modelling. Additionally we developed a new calculation method for the mass balance. By this method, we may save expensive measuring costs of high volume mass flow of organic material. Chapter 3 presents the documentation and measuring results of the prototype biogas plant in Järna. The plant is the first farm scale plant digesting fully automatically solid manure. It is also the first plant where a solid fraction is separated after the hydrolysis and before the methanisation phase. We present first time a complete mass, nutrient and energy balance of a continuously working solid manure biogas plant. In chapter 4 we conclude that long term research and development on dry fermentation on-farm is necessary. A more holistic approach is recommended because the economical assessment of on-farm biogas plants should always include the whole farm organism.			
Avainsanat (asiasanat) biokaasu, kuivamädätys, tekniset parametrit			
Sarjan nimi ja numero Agrifood Research Reports 77		ISSN-numero 1458-5073 Printed version 1458-5081 Electronic version	ISBN-numero 952-487-006-1 Printed version 952-487-007-X Electronic version
Kokonaismäärä	Kieli	Hinta 20 €	Luottamuksellisuus
Jakaja MTT Agrifood Research Finland, Animal Production Research Vakolantie 55, FI-03400 Vihti, Finland		Kustantaja	

## Appendix 2.

### Symbols and Abbreviations

A	$\text{m}^2$	reactor surface
$\alpha$	$\text{W m}^{-2} \text{K}^{-1}$	heat transfer coefficient
B	$\text{kg d}^{-1}$	biogas mass
C	$\text{kg d}^{-1}$	carbon dioxide in biogas
CHP-unit		combined heat power unit
E	$\text{kg d}^{-1}$	effluent mass
F	$\text{kg d}^{-1}$	faeces mass
c	%	average carbon content in biogas
$c_1$	%	carbon content in biogas of reactor 1
$c_2$	%	carbon content in biogas of reactor 2
G	$\text{m}^3 \text{d}^{-1}$	biogas yield
$G_B$	$\text{m}^3 \text{d}^{-1}$	biogas consumption of the process burner
$G_1$	$\text{m}^3 \text{d}^{-1}$	biogas yield of reactor 1
$G_2$	$\text{m}^3 \text{d}^{-1}$	biogas yield of reactor 2
H	$\text{kg d}^{-1}$	oat husk mass
l	$\text{kg m}^{-3} \text{d}^{-1}$	loading rate
$l_1$	$\text{kg m}^{-3} \text{d}^{-1}$	loading rate of reactor 1
$l_2$	$\text{kg m}^{-3} \text{d}^{-1}$	loading rate of reactor 2
L	$\text{kg d}^{-1}$	losses
$L_A$	$\text{kg d}^{-1}$	losses process A
$L_B$	$\text{kg d}^{-1}$	losses process B
LPG		liquid petrol gas
LU		livestock unit
M	$\text{kg d}^{-1}$	manure mass
ME	$\text{kg d}^{-1}$	methane in biogas

$Q_E$	$Wh\ d^{-1}$	electric power consumption
$Q_{Ex}$	$Wh\ d^{-1}$	energy losses of exhaust gas
$Q_H$	$Wh\ d^{-1}$	energy heating organic input material
$Q_I$	$Wh\ d^{-1}$	energy input
$Q_R$	$Wh\ d^{-1}$	energy maintaining reactor process temperature
$Q_{1in}$	$m^3\ d^{-1}$	volume of input reactor 1
$Q_{2in}$	$m^3\ d^{-1}$	volume of input reactor 2
$Q_{1out}$	$m^3\ d^{-1}$	volume of output reactor 1
$Q_{2out}$	$m^3\ d^{-1}$	volume of output reactor 2
$S$	$kg\ d^{-1}$	solid fraction mass
$SC$	$kg$	solid fraction compost
$STR$	$kg\ d^{-1}$	straw mass
$t$	$d$	retention time
$t_a$	$^{\circ}K$	environmental temperature
$t_i$	$^{\circ}K$	process temperature
$TS_E$	$\%$	total solids of effluent
$TS_H$	$\%$	total solids of oat husks
$TS_M$	$\%$	total solids of manure
$TS_{MC}$	$\%$	total solids of manure compost
$TS_S$	$\%$	total solids of solid fraction
$TS_{STR}$	$\%$	total solids of straw
$v$	$m^3\ m^{-3}\ d^{-1}$	volume efficiency
$V_1$	$m^3$	volume of reactor 1
$V_2$	$m^3$	volume of reactor 2
$VS_E$	$\%$	volatile solids of effluent
$VS_M$	$\%$	volatile solids of manure

$VS_S$	%	volatile solids of solid fraction
$w$	%	vapour content of biogas
$W$	$\text{kg d}^{-1}$	mass of vapour
$X$	$\text{kg d}^{-1}$	nutrient (N, P, K)
$X_{MC}$	$\text{kg d}^{-1}$	nutrient in manure compost
$X_E$	$\text{kg d}^{-1}$	nutrient in effluent
$X_H$	$\text{kg d}^{-1}$	nutrient in oat husks
$X_M$	$\text{kg d}^{-1}$	nutrient in manure
$X_S$	$\text{kg d}^{-1}$	nutrient in solid fraction
$X_{SC}$	$\text{kg d}^{-1}$	nutrient in solid fraction compost
$X_{STR}$	$\text{kg d}^{-1}$	nutrient in straw
$y$	$\text{l kg}^{-1} \text{VS}$	gas yield rate
$\rho_C$	$\text{kg m}^{-3}$	specific weight of carbon dioxide
$\rho_E$	$\text{kg m}^{-3}$	specific weight of the effluent
$\rho_M$	$\text{kg m}^{-3}$	specific weight of manure
$\rho_{ME}$	$\text{kg m}^{-3}$	specific weight of methane
$\rho_W$	$\text{kg m}^{-3}$	specific weight of vapour
$\rho_l$	$\text{kg m}^{-3}$	specific weight of the liquid fraction of reactor 1

Appendix 3.

Poster biogas plant in Järna

Biogas plant at Yttereneby, Järna, Sweden

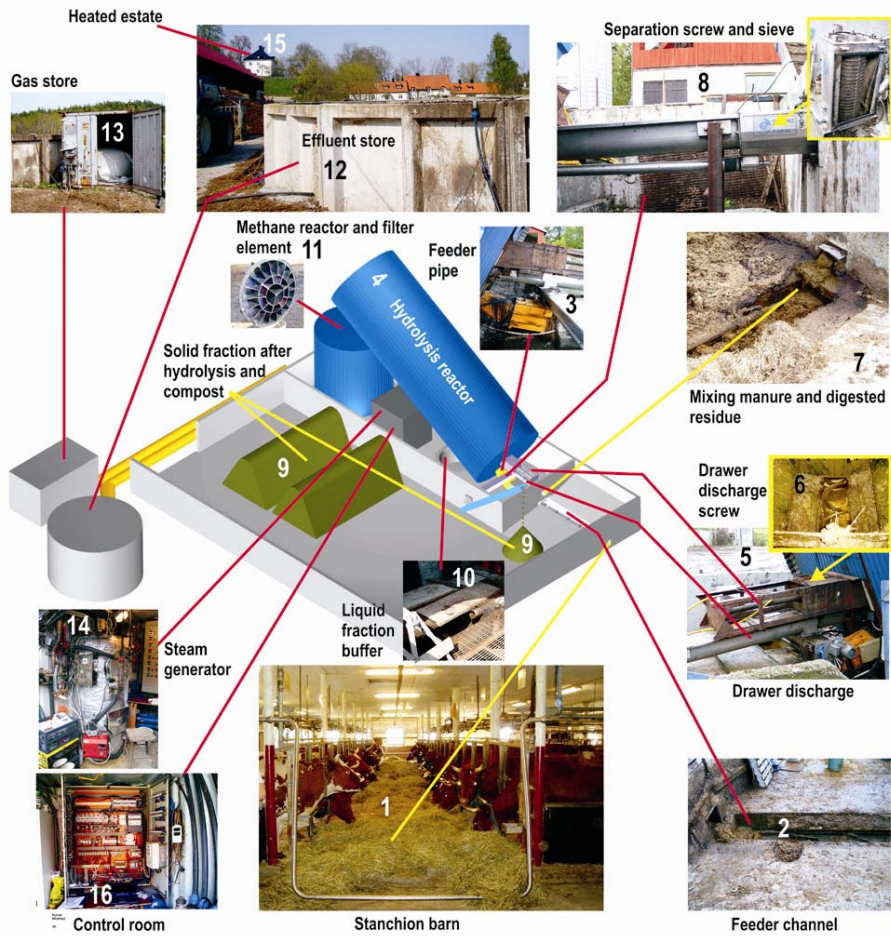

MTT Agricultural Engineering Research (Vakola), 03400 Vihti, Finland

Winfried Schäfer  
winfried.schafer@mtt.fi  
Puh. +358 9 2242 5220

Frederick Teye  
frederick.teye@mtt.fi  
Puh. +358 9 2242 5211



## Appendix 4.

### Laboratory results

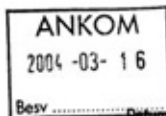

RAPPORT Sid: 1/1  
Utförd av ackrediterat laboratorium  
REPORT issued by an Accredited Laboratory

Kundnr 30680 Provnr 04-1348-1  
04-03-08

Uppdragsgivare: Ladugården

Stiftelsen  
Biodynamiska Forskningsinstitutet  
Skilleby  
153 95 JÄRNA

Finjens  
Rapport/Ladugården

#### Provuppgifter

Provet inkom: 04-03-04 14.30  
Provart: Gödsel  
Provtagningsplats: St. Biodynamiska Forsknin  
Provmärkning: Fast gödsel

#### Analysresultat

Torrsubstans  
Organiskt kväve  
Ammoniumkväve\*  
Kväve, total\*  
Kol, total  
Fosfor, total  
Nitrat och Nitritkväve

Metod	Enhet	
SS 028113-1	%	17,7 ± 6%
SS-ISO 13878	Kg/ton	4,54 ± 8%
Tecator ASN 50-01/92	Kg/ton	1,0
Beräknad	Kg/ton	5,6 ± 8%
SS-ISO 10694	Kg/ton	84 ± 15%
SS 028311	Kg/ton	1,15 ± 15%
	g/ton	1,7

#### Utlåtande och upplysningar

Återutskrift pga tillägg av parametrar.

Konjunkt  
S  
K  
Ca  
H  
osklat

Terese Uddh

Ansvarig undersökare/Högskoleing.

Den rapporterade osäkerheten är beräknad med täckningsfaktor k=2 och avser den totala osäkerheten för kemiska analyser.  
Laboratoriet ackrediteras av Sjösystem för ackreditering och osäkerhetskontroll (SWEDAC) enligt svensk lag. Verksamheten vid de svenska ackrediterade laboratorier uppfyller kraven i SS-EN ISO 17025 (2005). Dessa rapporter är endast ämpliga i sin helhet, om inte SWEDAC och utställande laboratorier i övrigt särskiljer godkända avse.

HS Miljölab AB  
Gas Jacobs gata 1  
392 45 KÄLMAR  
Tel 0480-49 33 88  
Fax 0480-239 50

E-post  
hslab@hsmiljolab.se

Hemsida  
www.hsmiljolab.se

Postgiro 4 08 44 86-2  
Bankgiro 5899-9558  
Org.nr. 556486-1754

Hushållningsutskäpet  
Kälmar-Kronoberg  
Rottbjälvsgränd 18  
392 41 KÄLMAR

F-skattebevis finns

**Datum** 04-03-08 **Kundnr** 30680 **Provnr** 04 - 1348 - 2

Uppdragsgivare:

Stiftelsen  
 Biodynamiska Forskningsinstitutet  
 Skilleby  
 153 95 JÄRNA

Ut på  
 godset/plått

Stiftelsen

**Provuppgifter**

**Provets inkom:** 04-03-04 14.30  
**Provart:** Gödning  
**Provtagningsplats:** St. Biodynamiska Forsknin  
**Provmärkning:** Fast gödning

**Analysresultat**

Torrsubstans  
 Organiskt kväve  
 Ammoniumkväve\*  
 Kväve, total\*  
 Kol, total  
 Fosfor, total  
 Nitrat och Nitritkväve

Metod	Enhet	Resultat
SS 028113-1	%	29,0 ± 6%
SS-ISO 13878	Kg/ton	4,0 ± 8%
Tecator ASN 50-01/92	Kg/ton	0,97
Beräknad	Kg/ton	5,0 ± 8%
SS-ISO 10694	Kg/ton	141 ± 15%
SS 028311	Kg/ton	0,94 ± 15%
	g/ton	1,9



Torise Uddh  
 Ansvarig undersökare/Högskoleing.

Den rapporterade osäkerheten är beräknad med täckningsfaktor k=2 och avser den totala osäkerheten för kemiska analyser.  
 Laboratoriets ackreditering av Stiftelsen för ackreditering och teknisk kontroll (SWEDAC) enligt svensk lag. Verksamheten vid de svenska ackrediterade laboratorierna uppfyller kraven i SS-EN ISO 17025 (2005). Denna rapport får endast användas i sin helhet, om inte SWEDAC och tillämpliga laboratorier i förväg skriftligen godkänner annat.





HS Miljölab AB

En företag inom  
Måttättningssektorn Kalmars-Kronoberg



## RAPPORT

Sid: 1/1

Utförd av ackrediterat laboratorium  
REPORT issued by an Accredited Laboratory

Datum 04-03-08  
Kundnr 30680

Provnr  
04 - 1348 - 3

Uppdragsgivare:

Filberni

Stiftelse  
Biodynamiska Forskn.institutet  
Skilleby  
153 95 JÄRNA

Erning out  
of the crop

Red pipe

Link

### Provuppgifter

Provet inkom: 04-03-04 14.30  
Provart: Gödsel  
Provtagningsplats: St. Biodynamiska Forsknin  
Provmärkning: Flytande gödsel

### Analysresultat

Torrsubstans  
Organiskt kväve  
Ammoniumkväve\*  
Kväve, total\*  
Kol, total  
Fosfor, total  
Nitrat och Nitritkväve

Metod	Enhet	
SS 028113-1	%	6,93 ± 6%
SS-ISO 13878	Kg/ton	2,64 ± 8%
Tecator ASN 50-01/92	Kg/ton	0,84
Beräknad	Kg/ton	3,5 ± 8%
SS-ISO 10694	Kg/ton	32 ± 15%
SS 028311	Kg/ton	0,82 ± 15%
	g/ton	1,7

Terese Uddh  
Ansvarig undersökare/Högskoleing.

Den rapporterade osäkerheten är beräknad med täckningsfaktorn 1-2 och avser den totala osäkerheten för kemiska analyser.  
Laboratoriet ackrediteras av Sveriges för ackreditering och teknisk kontroll (SWEDAC) enligt svensk lag. Yrkssamfundets vid de svenska ackrediterade laboratorier som uppfyller kraven i SS-EN-ISO 17025 (2005). Denna rapport är endast berägnad i sin helhet, om inte SWEDAC och utförande laboratoriet i förväg skriftligen godkännt annat.

HS Miljölab AB  
Gas Jacobs gata 1  
392 45 KALMAR  
Tel 0480-49 33 88  
Fax 0480-239 50

E-post  
hslab@hsmiljotab.se

Hemsida  
www.hsmiljotab.se

Postgiro 4 08 44 86-2  
Bankgiro 5899-9558  
Org.nr. 556486-1754

Måttättningssektorn  
Kalmars-Kronoberg  
Flottjivägen 18  
392 41 KALMAR

F-skattebevis finns

Datum 04-03-08 Kundnr 30680 Provrnr 04 - 1348 - 4

Uppdragsgivare:

Stiftelsen  
Biodynamiska Forskningsinstitutet  
Skilleby  
153 95 JÄRNA

*efter fel*

### Provuppgifter

Provet inkom: 04-03-04 14.30  
Provart: Gödsel  
Provtagningsplats: St. Biodynamiska Forsknin  
Provmärkning: Flytande gödsel

### Analysresultat

	Metod	Enhet	
Torrsubstans	SS 028113-1	%	<i>FM</i> 5,86 ± 6%
Total kväve	SS-ISO 13878	Kg/ton	3,9 ± 8%
Total Kol	SS-ISO 10694	Kg/ton	26 ± 15%

  
Terese Uddh  
Ansvarig undersökare/Högskoleing.

Den rapporterade osäkerheten är beräknad med täckningsfaktor 1-2 och avser den totala måttvärdeosäkerheten för kemiska analyser.  
Laboratoriet ackrediteras av Sveriges för ackreditering och teknisk kontroll (SWEDAC) enligt svensk lag. Verksamheten vid de svenska ackrediterade laboratorierna uppfyller kraven i SS-EN ISO 17025 (2005). Dessa rapporter får endast åtgäras i sin helhet, och inte SWEDAC och ackrediterade laboratorier i för sig skriftliga produkter annat.

Datum 04-03-08 Kundnr 30680 Provnr 04 - 1348 - 5

Uppdragsgivare:

Stiftelsen  
Biodynamiska Forskn.istitutet  
Skilleby  
153 95 JÄRNA

Duggås  
M. Eriksson  
Urn

### Provuppgifter

Provet inkom: 04-03-04 14.30  
Provart: Gödsel  
Provtagningsplats: St. Biodynamiska Forsknin  
Provmärkning: Flytande gödsel

### Analysresultat

	Metod	Enhet	
Torrsubstans	SS 028113-1	%	<b>1,32 ± 6%</b>
Organiskt kväve	SS-ISO 13878	Kg/ton	<b>0,24 ± 8%</b>
Ammoniumkväve*	Tecator ASN 50-01/92	Kg/ton	<b>1,0</b>
Kväve, total*	Beräknad	Kg/ton	<b>1,3 ± 8%</b>
Kol, total	SS-ISO 10694	Kg/ton	<b>4,0 ± 15%</b>
Fosfor, total	SS 028311	Kg/ton	<b>0,03 ± 15%</b>
Nitrat och Nitritkväve		g/ton	<b>0,73</b>



Terese Uddh  
Ansvarig undersökare/Högskoleing.

Den rapporterade osäkerheten är beräknad med täckningsfaktor k=2 och avser den totala måttosäkerheten för kemiska analyser.  
Laboratoriet ackrediteras av Styrelsen för ackreditering och teknisk kontroll (SWEDAC) enligt svensk lag. Verksamheten vid de svenska ackrediterade laboratorierna uppfyller kraven i SS-EN/IEC 17025 (2000). Denna rapport får endast återges i sin helhet, om inte SWEDAC och utförande laboratorium i förväg skriftligen godkännt annat.

**TUTKIMUSRAPORTTI N:o K 242/5/1-6**

(1/4) K 242/5/1-6

**Tilaaaja** Maatalouden tutkimuskeskus Vakola  
Vakolantie 55  
03400 Vihti

**Tilaus** Tilaus 16.3.2005 / Marja Lehto, tilausno 04404, fax. 224 6210

**Tulopäivä** 16.3.2005 Analysoinnin aloituspäivä 17.3.2005

**Tehtävä** Näytteen kuiva-aineen, tilavuuspainon, liukoisen typen, kokonaistypen, ammoniumtypen, fosforin ja kaliumin pitoisuuden sekä enterokokkien analysointi.

**Näyte** Kuusi näytettä

**Analyysimenetelmät**

Liukoinen tyyppi ja ammoniumtyppi uutettiin 0.1 M K<sub>2</sub>SO<sub>4</sub>-liuokseen ja analysoitiin Kjeldahl menetelmällä. Kokonaistyyppi analysoitiin Kjeldahl menetelmällä (Novalab 001). Kuiva-aine määritettiin lämpökaappimenetelmällä (Novalab 010). Tilavuuspaino määritettiin mittalasia ja vaakaa käyttäen. Kuivattu näyte jauhettiin ja siitä määritettiin kuivapolton ja suolahappoliuotuksen jälkeen atomiabsorptiospektrometrillä kaliumin (Novalab 007.A) ja spektrofotometrillä fosforin pitoisuus (Novalab 005). Näytteen enterokokit analysoitiin NMKL 68:2004 menetelmällä 'Enterococcus. Määrittäminen elintarvikkeista ja rehuista' (NMKL=The Nordic Committee on Food Analysis). Menetelmää voidaan soveltaa myös lanta- ja kompostinäytteille. Enterokokit varmistettiin katalaasitestillä, eskuliinin hydrolyysillä sappieskuliini-atsidiagarilla sekä Ani Biotech Oy:n ANI Strep D agglutinaatiotestillä.

**Tulokset** Näyte 1: 5. Lanta, tulokset tulokostean näytteeseen laskettuna

MÄÄRITYS	TULOS	
kuiva-aine	28.6 %	
	kg/tn	kg/m <sup>3</sup>
tilavuuspaino		526
liukoinen tyyppi	0.12	0.07
kokonaistyyppi	6.7	3.5
ammoniumtyppi	0.05	0.03
kalium	12.0	6.2
fosfori	2.0	1.1

Määrittäminen	Tulos
Enterokokit	arvio 5.0 x 10 <sup>2</sup>

**Näyte 2: 6. Kuiva, tulokset tulokostetaan näytteeseen laskettuna**

MÄÄRITYS	TULOS	
kuiva-aine	65.3 %	
	kg/tn	kg/m <sup>3</sup>
tilavuuspaino		173
liukoinen tyyppi	0.31	0.05
kokonaistyyppi	14.5	2.5
ammoniumtyppi	0.11	0.02
kalium	15.0	2.6
fosfori	2.8	0.49

Määrittäminen	Tulos pmy/g
Enterokokit	arvio 4.5 x 10 <sup>2</sup>

**Näyte 3: 7. Lanta, tulokset tulokostetaan näytteeseen laskettuna**

MÄÄRITYS	TULOS	
kuiva-aine	39.7 %	
	kg/tn	kg/m <sup>3</sup>
tilavuuspaino		297
liukoinen tyyppi	0.60	0.18
kokonaistyyppi	9.9	2.9
ammoniumtyppi	0.07	0.02
kalium	16.0	4.9
fosfori	2.7	0.81

Määrittäminen	Tulos pmy/g
Enterokokit	< 10 <sup>2</sup>

**Näyte 4: 8. Kuiva, tulokset tulokostetaan näytteeseen laskettuna**

MÄÄRITYS	TULOS	
kuiva-aine	54.4 %	
	kg/tn	kg/m <sup>3</sup>
tilavuuspaino		236
liukoinen tyyppi	0.37	0.09
kokonaistyyppi	12.8	3.0
ammoniumtyppi	0.09	0.02
kalium	14.0	3.4
fosfori	2.8	0.67

Määrittäminen	Tulos pmy/g
Enterokokit	arvio 1.5 x 10 <sup>2</sup>

**Näyte 5:** 9. Lanta, tulokset tulokostetaan näytteeseen laskettuna

MÄÄRITYS	TULOS	
kuiva-aine	42.9 %	
	kg/tn	kg/m <sup>3</sup>
tilavuuspaino		306
liukoinen tyyppi	0.52	0.16
kokonaistyyppi	9.6	2.9
ammoniumtyyppi	0.07	0.02
kalium	17.0	5.1
fosfori	2.7	0.84

Määrittäminen	Tulos
Enterokokit	arvio 50

**Näyte 6:** 10. Kuiva, tulokset tulokostetaan näytteeseen laskettuna

MÄÄRITYS	TULOS	
kuiva-aine	61.2 %	
	kg/tn	kg/m <sup>3</sup>
tilavuuspaino		184
liukoinen tyyppi	0.54	0.10
kokonaistyyppi	14.4	2.7
ammoniumtyyppi	0.26	0.05
kalium	17.0	3.1
fosfori	2.9	0.54

Määrittäminen	Tulos
Enterokokit	< 10 <sup>2</sup>

**Tulosten mittausepävarmuudet**

Näyte	kuiva-aine suht-%	N-kok %	N-liuk %	NH <sub>4</sub> -N %	P %	K %
1.	± 1.0	± 10	± 50	± 100	± 10	± 10
2.	± 1.0	± 10	± 30	± 50	± 10	± 10
3.	± 1.0	± 10	± 20	± 50	± 10	± 10
4.	± 1.0	± 10	± 30	± 50	± 10	± 10
5.	± 1.0	± 10	± 20	± 50	± 10	± 10
6.	± 1.0	± 10	± 20	± 30	± 10	± 10

Mittausepävarmuudet koskevat vain kg/tn -yksikössä olevia tuloksia.

**Yhdistetty suhteellinen mittausepävarmuus**

Näyte	enterokokit %
1.	31.8
2.	33.5
3.	0
4.	57.8
5.	70.8
6.	0

Näytteen enterokokkituloksen mittausepävarmuus on laskettu hiukkastilastollisen hajonnan, koeannoksen tilavuuden epävarmuuden, laimennuksen epävarmuuden, varmistuvuuden epävarmuuden ja lukemaepävarmuuden yhdistettynä suhteellisena epävarmuutena.

Karkkila 4.4.2005

Novalab Oy

Matti Mäkelä  
laboratorionjohtaja

Terhi Tuomala-Saramäki  
osastopäällikkö

Tulokset pätevät vain testatuille näytteille. Raportin saa kopioida vain kokonaan ilman testauslaboratorion lupaa.

Toimisto ja laboratorio  
Lepolantie 5  
FIN-03600 Karkkila  
Finland

☎ (09) 2252 860  
fax (09) 2252 8660  
www.novalab.fi

Pankki  
Länsi-Uudenmaan Op  
Karkkila  
529728-2716

Y-tunnus 0733227-8  
Kotipaikka Karkkila  
Alv.rek.

**TUTKIMUSRAPORTTI N:o K 677/4/1**

Tilaaaja MTT / Maatalousteknologian tutkimus  
Vakolantie 55  
03400 Vihti

Tilaus Tilaus 7.5.2004 / Winfried Schäfer Tulopäivä 7.5.2004 Aloituspäivä 7.5.2004

Tehtävä Näytteen kuiva-aineen, tilavuuspainon, liukoisen typen, kokonaistypen, ammonium-  
typen, fosforin ja kaliumin pitoisuuden sekä enterokokkien analysointi.

Näyte Yksi lantanäyte ( No 1 ) (kuiva)

**Analysimenetelmät**

Liukoinen tyyppi ja ammoniumtyyppi uutettiin 0.1 M K<sub>2</sub>SO<sub>4</sub>-liuokseen ja analysoitiin Kjeldahl menetelmällä. Kokonaistyyppi analysoitiin Kjeldahl menetelmällä (Novalab 001). Kuiva-aine määritettiin lämpökaappimenetelmällä (Novalab 010). Tilavuuspaino määritettiin mittalasia ja vaakaa käyttäen. Kuivattu näyte jauhettiin ja siitä määritettiin kuivapolton ja suolahappoliuotuksen jälkeen atomilabsorptiospektrometrillä kaliumin ja spektrofotometrillä fosforin pitoisuus (Novalab 005). Enterokokit määritettiin menetelmällä NMKL 68:1992.

Tulokset **Näyte 1:** Lanta, tulokset tulokosteaan näytteeseen laskettuna

Määrittäminen	Tulos	
kuiva-aine	24.7 %	
	kg/tn	kg/m <sup>3</sup>
tilavuuspaino		476
liukoinen tyyppi	0.51	0.25
kokonaistyyppi	3.6	1.7
ammoniumtyyppi	0.39	0.19
kalium	3.1	1.5
fosfori	0.71	0.34

Määrittäminen	Tulos
Enterokokit	4.2 x 10 <sup>5</sup>

Karkkila 19.5.2004

Novalab Oy

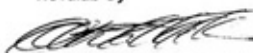
Matti Mäkelä  
laboratorionjohtajaTerhi Tuomala-Saramäki  
osastopäällikkö

Tulokset pätevät vain testatuille näytteille. Raportin saa kopioida vain kokonaan ilman testauslaboratorion lupaa.

Toimisto ja laboratorio  
Lepolantie 5  
FIN-03600 Karkkila  
Finland☎ (09) 2252 860  
fax (09) 2252 8660  
www.novalab.fiPankki  
Länsi-Uudenmaan Op  
Karkkila  
529728-2716Kaupparek.nro. 441981  
Kotipaikka Karkkila  
Alv.rek.



**TUTKIMUSRAPORTTI N:o K 677/4/2**

Tilaja MTT / Maatalousteknologian tutkimus  
Vakolantie 55  
03400 Vihti

Tilaus Tilaus 7.5.2004 / Winfried Schäfer Tulopäivä 7.5.2004 Aloituspäivä 7.5.2004

Tehtävä Näytteen kuiva-aineen, tilavuuspainon, liukaisen typen, kokonaistypen, ammonium-  
typen, fosforin ja kaliumin pitoisuuden analysointi.

Näyte Yksi lantanäyte (No 3) (Kuiva-aine)

**Analyysimenetelmät**

Liukoinen tyyppi ja ammoniumtyppi uutettiin 0.1 M  $K_2SO_4$ -liuokseen ja analysoitiin Kjeldahl menetelmällä. Kokonaistyyppi analysoitiin Kjeldahl menetelmällä (Novalab 001). Kuiva-aine määritettiin lämpökaappimenetelmällä (Novalab 010). Tilavuuspaino määritettiin mittalasia ja vaakaa käyttäen. Kuivattu näyte jauhettiin ja siitä määritettiin kuivapolton ja suolahappoliuotuksen jälkeen atomiabsorptiospektrometrillä kaliumin ja spektrofotometrillä fosforin pitoisuus (Novalab 005).

Tulokset **Näyte 2:** Lanta, tulokset tulokosteaan näytteeseen laskettuna

Määrittäminen	Tulos	
	kg/tn	kg/m <sup>3</sup>
kuiva-aine	15.8 %	
tilavuuspaino		968
liukoinen tyyppi	0.89	0.86
kokonaistyyppi	4.0	3.8
ammoniumtyppi	0.83	0.80
kalium	4.1	4.0
fosfori	0.87	0.84

Karkkila 19.5.2004

Novalab Oy



Matti Mäkelä  
laboratorionjohtaja

Tulokset pätevät vain testatuille näytteille. Raportin saa kopioida vain kokonaan ilman testauslaboratorion lupaa.

**TUTKIMUSRAPORTTI N:o K 677/4/3**

Tilaja MTT / Maatalousteknologian tutkimus  
Vakolantie 55  
03400 Vihti

Tilaus Tilaus 7.5.2004 / Winfried Schäfer Tulopäivä 7.5.2004 Aloituspäivä 7.5.2004

Tehtävä Näytteen kuiva-aineen, tilavuuspainon, liukaisen typen, kokonaistypen, ammonium-  
typen, fosforin ja kaliumin pitoisuuden sekä rasvahappojen analysointi.

Näyte Yksi lantanäyte ( No 5) *lieke*

**Analysimenetelmät**

Liukoinen tyyppi ja ammoniumtyppi uutettiin 0.1 M  $K_2SO_4$ -liuokseen ja analysoitiin Kjeldahl menetelmällä. Kokonaistyyppi analysoitiin Kjeldahl menetelmällä (Novalab 001). Kuiva-aine määritettiin lämpökaappimenetelmällä (Novalab 010). Tilavuuspaino määritettiin mittalasia ja vaakaa käyttäen. Kuivattu näyte jauhettiin ja siitä määritettiin kuivapolton ja suolahappoliuotuksen jälkeen atomiabsorptiospektrometrillä kaliumin ja spektrofotometrillä fosforin pitoisuus (Novalab 005). Veteen liuotetuista näytteistä etikkahappo, propionihappo ja voihapo määritettiin nestekromatografisesti käyttäen ulkoista standardia (Novalab 031).

Tulokset **Näyte 3:** Lanta, tulokset tulokostean näytteeseen laskettuna

Määritys	Tulos	
kuiva-aine	7.1 %	
	kg/tn	kg/m <sup>3</sup>
tilavuuspaino		968
liukoinen tyyppi	1.1	1.1
kokonaistyyppi	3.6	3.4
ammoniumtyppi	0.88	0.86
kalium	3.7	3.6
fosfori	0.85	0.83

Määritys	Tulos mg/kg
etikkahappo	57
propionihappo	< 50
voihapo	< 10

Karkkila 19.5.2004

Novalab Oy



Matti Mäkelä  
laboratorionjohtaja

Tulokset pätevät vain testatuille näytteille. Raportin saa kopioida vain kokonaan ilman testauslaboratorion lupaa.

Toimisto ja laboratorio  
Lepolantie 5  
FIN-03600 Karkkila  
Finland

☎ (09) 2252 860  
fax (09) 2252 8660  
www.novalab.fi

Pankki  
Länsi-Uudenmaan Op  
Karkkila  
529728-2716

Kaupparek.nro. 441981  
Kotipaikka Karkkila  
Alv.rek.

**TUTKIMUSRAPORTTI N:o K 677/4/4**

Tilaja MTT / Maatalousteknologian tutkimus  
Vakolantie 55  
03400 Vihti

Tilaus Tilaus 7.5.2004 / Winfried Schäfer Tulopäivä 7.5.2004 Aloituspäivä 7.5.2004

Tehtävä Näytteen kuiva-aineen, tilavuuspainon, liukaisen tyypen, kokonaistypen, ammonium-  
tyypen, fosforin ja kaliumin pitoisuuden sekä enterokokkien analysointi.

Näyte Yksi lantanäyte ( No 7 ) *Lanta*

**Analyysimenetelmät**

Liukoinen tyyppi ja ammoniumtyppi uutettiin 0.1 M  $K_2SO_4$ -liuokseen ja analysoitiin Kjeldahl menetelmällä. Kokonaistyyppi analysoitiin Kjeldahl menetelmällä (Novalab 001). Kuiva-aine määritettiin lämpökaappimenetelmällä (Novalab 010). Tilavuuspaino määritettiin mittalasia ja vaakaa käyttäen. Kuivattu näyte jauhettiin ja siitä määritettiin kuivapolton ja suolahappoliuotuksen jälkeen atomiabsorptiospektrometrillä kaliumin ja spektrofotometrillä fosforin pitoisuus (Novalab 005). Enterokokit määritettiin menetelmällä NMKL 68:1992.

Tulokset **Näyte 4:** Lanta, tulokset tulokosteaan näytteeseen laskettuna

Määrittäminen	Tulos	
	kg/tn	kg/m <sup>3</sup>
kuiva-aine	19.6 %	
tilavuuspaino		946
liukoinen tyyppi	0.58	0.55
kokonaistyyppi	3.4	3.3
ammoniumtyppi	0.34	0.32
kalium	3.9	3.7
fosfori	1.1	1.0

Määrittäminen	Tulos
Enterokokit	2.5 x 10 <sup>7</sup>

Karkkila 19.5.2004

Novalab Oy



Matti Mäkelä  
laboratorionjohtaja



Terhi Tuomala-Saramäki  
osastopäällikkö

Tulokset pätevät vain testatuille näytteille. Raportin saa kopioida vain kokonaan ilman testauslaboratorion lupaa.

Toimisto ja laboratorio  
Lepolantie 5  
FIN-03600 Karkkila  
Finland

☎ (09) 2252 860  
fax (09) 2252 8660  
www.novalab.fi

Pankki  
Länsi-Uudenmaan Op  
Karkkila  
529728-2716

Kaupparek.nro. 441981  
Kotipaikka Karkkila  
Alv.rek.

**TUTKIMUSRAPORTTI N:o K 677/4/5**

Tilaaaja MTT / Maatalousteknologian tutkimus  
Vakolantie 55  
03400 Vihti

Tilaus Tilaus 7.5.2004 / Winfried Schäfer Tulopäivä 7.5.2004 Aloituspäivä 7.5.2004

Tehtävä Näytteen kuiva-aineen, tilavuuspainon, liukoisen typen, kokonaistypen, ammonium-  
typen, fosforin ja kaliumin pitoisuuden analysointi.

Näyte Yksi lantanäyte ( No 9 ) *kuiva-ainepitoisuus*

**Analyysimenetelmät**

Liukoinen tyyppi ja ammoniumtyppi uutettiin 0.1 M  $K_2SO_4$ -liuokseen ja analysoitiin Kjeldahl menetelmällä. Kokonaistyyppi analysoitiin Kjeldahl menetelmällä (Novalab 001). Kuiva-aine määritettiin lämpökaappimenetelmällä (Novalab 010). Tilavuuspaino määritettiin mittalasia ja vaakaa käyttäen. Kuivattu näyte jauhettiin ja siitä määritettiin kuivapolton ja suolahappoliuotuksen jälkeen atomiabsorptiospektrometrillä kaliumin ja spektrofotometrillä fosforin pitoisuus (Novalab 005).

Tulokset **Näyte 5:** Lanta, tulokset tulokostean näyteeseen laskettuna

Määritys	Tulos	
	kg/tn	kg/m <sup>3</sup>
kuiva-aine	5.6 %	
tilavuuspaino		997
liukoinen tyyppi	1.4	1.4
kokonaistyyppi	3.5	3.5
ammoniumtyppi	1.2	1.2
kalium	3.4	3.4
fosfori	0.79	0.79

Karkkila 19.5.2004

Novalab Oy



Matti Mäkelä  
laboratorionjohtaja

Tulokset pätevät vain testatuille näytteille. Raportin saa kopioida vain kokonaan ilman testaustalaboratorion lupaa.

Toimisto ja laboratorio  
Lepolantie 5  
FIN-03600 Karkkila  
Finland

☎ (09) 2252 860  
fax (09) 2252 8660  
www.novalab.fi

Pankki  
Länsi-Uudenmaan Op  
Karkkila  
529728-2716

Kaupparek.nro. 441981  
Kotipaikka Karkkila  
Alv.rek.

**TUTKIMUSRAPORTTI N:o K 677/4/6**

Tilaaaja MTT / Maatalousteknologian tutkimus  
Vakolantie 55  
03400 Vihti

Tilaus Tilaus 7.5.2004 / Winfried Schäfer Tulopäivä 7.5.2004 Aloituspäivä 7.5.2004

Tehtävä Näytteen kuiva-aineen, kokonaistypen, fosforin ja kaliumin pitoisuuden analysointi.

Näyte Yksi olkinäyte

**Analysimenetelmät**

Kuiva-aine määritettiin lämpökaappimenetelmällä (Novalab 010\*). Kokonaistyyppi analysoitiin Kjeldahl menetelmällä (Novalab 001\*). Kuivattu näyte jauhettiin ja siitä määritettiin kuivapolton ja suolahappoliuotuksen jälkeen atomiabsorptio-spektrometrillä kaliumin (Novalab 007.A\*) ja spektrofotometrillä fosforin pitoisuus (Novalab 005.A\*).

Tulokset **Näyte 6:** Oiki, tulokset tulokostetaan näytteeseen laskettuna

Määrittäminen	Tulos
kuiva-aine*	90.9 %
	kg/tn
kokonaistyyppi*	5.5
kalium*	23
fosfori*	1.4

\* Akkreditoitu menetelmä.

Karkkila 19.5.2004

Novalab Oy



Matti Mäkelä  
laboratorionjohtaja



**T071 (EN ISO/IEC 17025)**

Tulokset pätevät vain testatuille näytteille. Raportin saa kopioida vain kokonaan ilman testauslaboratorion lupaa.

Toimisto ja laboratorio  
Lepolantie 5  
FIN-03600 Karkkila  
Finland

☎ (09) 2252 860  
fax (09) 2252 8660  
www.novalab.fi

Pankki  
Länsi-Uudenmaan Op  
Karkkila  
529728-2716

Kaupparek.nro. 441981  
Kotipaikka Karkkila  
Alv.rek.

**TUTKIMUSRAPORTTI N:o K 677/4/7**

Tilaja MTT / Maatalousteknologian tutkimus  
Vakolantie 55  
03400 Vihti

Tilaus Tilaus 7.5.2004 / Winfried Schäfer Tulopäivä 7.5.2004 Aloituspäivä 7.5.2004

Tehtävä Näytteen kuiva-aineen, tilavuuspainon, liukoisen typen, kokonaistypen, fosforin ja kaliumin pitoisuuden analysointi.

Näyte Yksi akananäyte

**Analyysimenetelmät**

Liukoinen tyyppi ja ammoniumtyppi uutettiin 0.1 M K<sub>2</sub>SO<sub>4</sub>-liuokseen ja analysoitiin Kjeldahl menetelmällä. Kokonaistyyppi analysoitiin Kjeldahl menetelmällä (Novalab 001\*). Kuiva-aine määritettiin lämpökaappimenetelmällä (Novalab 010\*). Tilavuuspaino määritettiin mittalasia ja vaakaa käyttäen. Kuivattu näyte jauhettiin ja siitä määritettiin kuivapolton ja suolahappoliuotuksen jälkeen atomiabsorptiospektrometrillä kaliumin (Novalab 007.A\*) ja spektrofotometrillä fosforin pitoisuus (Novalab 005.A\*).

Tulokset **Näyte 7:** Akana, tulokset tulokostean näytteeseen iaskettuna

Määrittäminen	Tulos	
kuiva-aine*	93.1 %	
	kg/tn	kg/m <sup>3</sup>
tilavuuspaino		323
liukoinen tyyppi	0.07	0.02
kokonaistyyppi*	2.2	0.70
kalium*	4.4	1.4
fosfori*	0.61	0.20

\* Akkreditoitu menetelmä.

Karkkila 19.5.2004

Novalab Oy



Matti Mäkelä  
laboratorionjohtaja



T071 (EN ISO/IEC 17025)

Tulokset pätevät vain testatuille näytteille. Raportin saa kopioida vain kokonaan ilman testauslaboratorion lupaa.

Toimisto ja laboratorio  
Lepolantie 5  
FIN-03600 Karkkila  
Finland

☎ (09) 2252 860  
fax (09) 2252 8660  
www.novalab.fi

Pankki  
Länsi-Uudenmaan Op  
Karkkila  
529728-2716

Kaupparek.nro. 441981  
Kotipaikka Karkkila  
Alv.rek.

**TUTKIMUSRAPORTTI N:o M 743/4/1-3**

Tilaaja Maatalouden tutkimuskeskus Vakola  
 Vakolantie 55  
 03400 Vihti  
 fax. 224 6210

Tilaus Tilaus / Winfried Schäfer

Tulopäivä 13.8.2004 Analysoinnin aloituspäivä 13.8.2004

Tehtävä Näytteen kuiva-aineen, tilavuuspainon, liukaisen tyypin, kokonaistypen, ammoniumtyypen, fosforin ja kaliumin pitoisuuden sekä enterokokkien analysointi.

Näyte Kolme kompostinäytettä

Tulokset **Näyte 1:** Komposti 1, tulokset tulokostetaan näytteeseen laskettuna

MÄÄRITYS	TULOS	
kuiva-aine	45.1 %	
	kg/tn	kg/m <sup>3</sup>
tilavuuspaino		236
liukoinen tyyppi	0.07	0.01
kokonaistyyppi	7.5	1.8
ammoniumtyppi	0.07	0.02
kalium	7.5	1.8
fosfori	1.7	0.41

Määrittäminen	Tulos pmy/g
Enterokokit	2.0 x 10 <sup>3</sup>

**Näyte 2:** Komposti 2, tulokset tulokostetaan näytteeseen laskettuna

MÄÄRITYS	TULOS	
kuiva-aine	24.1 %	
	kg/tn	kg/m <sup>3</sup>
tilavuuspaino		750
liukoinen tyyppi	0.13	0.10
kokonaistyyppi	5.3	4.0
ammoniumtyppi	0.06	0.05
kalium	6.8	5.1
fosfori	2.0	1.5

Määrittäminen	Tulos pmy/g
Enterokokit	arvio 2.7 x 10 <sup>2</sup>



(Tutkimusraportti M 743/4/1-3)

**Näyte 3: Komposti 4, tulokset tulokostetaan näytteeseen laskettuna**

MÄÄRITYS	TULOS	
kuiva-aine	24.9 %	
	kg/tn	kg/m <sup>3</sup>
tilavuuspaino		708
liukoinen tyyppi	0.15	0.10
kokonaistyyppi	5.3	3.8
ammoniumtyppi	0.05	0.04
kalium	7.0	4.9
fosfori	1.5	1.1

Määritys	Tulos pmy/g
Enterokokit	4.4 x 10 <sup>5</sup>

**Analysimenetelmät**

Liukoinen tyyppi ja ammoniumtyppi uutettiin 0.1 M K<sub>2</sub>SO<sub>4</sub>-liuokseen ja analysoitiin Kjeldahl menetelmällä. Kokonaistyyppi analysoitiin Kjeldahl menetelmällä (Novalab 001). Kuiva-aine määritettiin lämpökaappimenetelmällä (Novalab 010). Tilavuuspaino määritettiin mittalasia ja vaakaa käyttäen. Kuivattu näyte jauhettiin ja siitä määritettiin kuivapolton ja suolahappoliuotuksen jälkeen atomiabsorptiospektrometrillä kaliumin ja spektrofotometrillä fosforin pitoisuus (Novalab 005). Enterokokit määritettiin menetelmällä NMKL 68:2003 (Novalab 520).

Tämä tutkimusraportti korvaa 24.8.2004 päivätyn raportin.

Karkkila 9.9.2004

Novalab Oy

Matti Mäkelä  
laboratorionjohtaja

Terhi Tuomala-Saramäki  
osastopäällikkö

Tulokset pätevät vain testatuille näytteille. Raportin saa kopioida vain kokonaan ilman testauslaboratorion lupaa.

Toimisto ja laboratorio  
Lepolantie 5  
FIN-03600 Karkkila  
Finland

☎ (09) 2252 860  
fax (09) 2252 8660  
www.novalab.fi

Pankki  
Länsi-Uudenmaan Op  
Karkkila  
529728-2716

Y-tunnus 0733227-8  
Kotipaikka Karkkila  
Alv.rek.



**TUTKIMUSRAPORTTI N:o K 1859/4/1-6**

(1/4) K 1859/4/1-6

Tilaja Maatalouden tutkimuskeskus Vakola  
Vakolantie 55  
03400 Vihti  
fax. 224 6210

Tilaus Tilaus 27.10.2004 / Winfried Schäfer

Tulopäivä 27.10.2004 Analysoinnin aloituspäivä 28.10.2004

Tehtävä Näytteen kuiva-aineen, tilavuuspainon, liukoisen typen, kokonaistypen, ammoniumtypen, fosforin ja kaliumin pitoisuuden sekä enterokokkien analysointi.

Näyte Kuusi näytettä

**Analyysimenetelmät**

Liukoinen tyyppi ja ammoniumtyppi uutettiin 0.1 M K<sub>2</sub>SO<sub>4</sub>-liuokseen ja analysoitiin Kjeldahl menetelmällä. Kokonaistyyppi analysoitiin Kjeldahl menetelmällä (Novalab 001). Kuiva-aine määritettiin lämpökaappimenetelmällä (Novalab 010). Tilavuuspaino määritettiin mittalasia ja vaakaa käyttäen. Kuivattu näyte jauhettiin ja siitä määritettiin kuivapolton ja suolahappoliuotuksen jälkeen atomlabsorptiospektrometrillä kaliumin ja spektrofotometrillä fosforin pitoisuus (Novalab 005). Näytteen enterokokit analysoitiin NMKL 68:2003 menetelmällä 'Enterococcus. Määrittäminen elintarvikkeista ja rehuista' (NMKL=The Nordic Committee on Food Analysis). Menetelmää voidaan soveltaa myös lanta- ja kompostinäytteille. Enterokokit varmistettiin katalaasitestillä, eskuliinin hydrolyysillä sappieskuliini-atsidiagarilla sekä Ani Biotech Oy:n ANI Strep D agglutinaatiotestillä.

Tulokset **Näyte 1:** Lanta M16, tulokset tulokostean näytteeseen laskettuna

MÄÄRITYS	TULOS	
kuiva-aine	18.1 %	
	kg/tn	kg/m <sup>3</sup>
tilavuuspaino		969
liukoinen tyyppi	0.69	0.66
kokonaistyyppi	3.5	3.4
ammoniumtyppi	0.45	0.44
kalium	4.7	4.6
fosfori	0.68	0.66

Määrittäminen	Tulos
Enterokokit	3.3 x 10 <sup>5</sup>

Toimisto ja laboratorio  
Lepolantie 5  
FIN-03600 Karkkila  
Finland

☎ (09) 2252 860  
fax (09) 2252 8660  
www.novalab.fi

Pankki  
Länsi-Uudenmaan Op  
Karkkila  
529728-2716

Y-tunnus 0733227-8  
Kotipaikka Karkkila  
Alv.rek.



**Näyte 2:** Kuivafraktio D20, tulokset tulokostean näytteeseen laskettuna

MÄÄRITYS	TULOS	
kuiva-aine	27.3 %	
	kg/tn	kg/m <sup>3</sup>
tilavuuspaino		487
liukoinen tyyppi	0.63	0.31
kokonaistyyppi	3.7	1.8
ammoniumtyppi	0.44	0.21
kallium	3.9	1.9
fosfori	0.71	0.35

Määritys	Tulos pmy/g
Enterokokit	2.4 x 10 <sup>5</sup>

**Näyte 3:** Neste L22, tulokset tulokostean näytteeseen laskettuna

MÄÄRITYS	TULOS	
kuiva-aine	5.5 %	
	kg/tn	kg/m <sup>3</sup>
tilavuuspaino		1015
liukoinen tyyppi	0.99	1.0
kokonaistyyppi	3.1	3.2
ammoniumtyppi	0.87	0.88
kallium	3.6	3.7
fosfori	0.66	0.67

**Näyte 4:** Effluent E24, tulokset tulokostean näytteeseen laskettuna

MÄÄRITYS	TULOS	
kuiva-aine	3.9 %	
	kg/tn	kg/m <sup>3</sup>
tilavuuspaino		1026
liukoinen tyyppi	1.1	1.1
kokonaistyyppi	2.5	2.6
ammoniumtyppi	1.0	1.0
kallium	3.2	3.3
fosfori	0.51	0.52

Määritys	Tulos pmy/g
Enterokokit	4.5 x 10 <sup>4</sup>

**Näyte 5: Oiki S26, tulokset tulokostean näytteeseen laskettuna**

MÄÄRITYS	TULOS	
kuiva-aine	82.2 %	
	kg/tn	kg/m <sup>3</sup>
tilavuuspaino		485
liukoinen tyyppi	0.19	0.09
kokonaistyyppi	4.1	2.0
ammoniumtyyppi	0.13	0.07
kaliium	5.4	2.6
fosfori	0.88	0.43

**Näyte 6: Akana H28, tulokset tulokostean näytteeseen laskettuna**

MÄÄRITYS	TULOS	
kuiva-aine	92.5 %	
	kg/tn	kg/m <sup>3</sup>
tilavuuspaino		170
liukoinen tyyppi	0.10	0.02
kokonaistyyppi	3.0	0.51
ammoniumtyyppi	0.05	0.01
kallium	5.5	0.93
fosfori	1.0	0.18

**Tulosten mittausepävarmuudet**

Näyte	kuiva-aine suht-%	N-kok %	N-liuk %	NH <sub>4</sub> -N %	P %	K %
1.	± 1.0	± 10	± 20	± 30	± 10	± 10
2.	± 1.0	± 10	± 20	± 30	± 10	± 10
3.	± 2.0	± 10	± 20	± 20	± 10	± 10
4.	± 2.0	± 10	± 20	± 20	± 10	± 10
5.	± 1.0	± 10	± 50	± 50	± 10	± 10
6.	± 1.0	± 10	± 50	± 50	± 10	± 10

Mittausepävarmuudet koskevat vain kg/tn -yksikössä olevia tuloksia.

**Yhdistetty suhteellinen mittausepävarmuus**

Näyte	enterokokit %
1.	12.1
2.	14.1
4.	14.6

Näytteen enterokokkituloksen mittausepävarmuus on laskettu hiukkastilastollisen hajonnan, koeannoksen tilavuuden epävarmuuden, laimennuksen epävarmuuden, varmistuvuuden epävarmuuden ja lukemaepävarmuuden yhdistettynä suhteellisenä epävarmuutena.



Karkkila 4.11.2004

Novalab Oy

Matti Mäkelä  
laboratorionjohtaja

Terhi Tuomala-Saramäki  
osastopäällikkö

Tulokset pätevät vain testatuille näytteille. Raportin saa kopioida vain kokonaan ilman testauslaboratorion lupaa.

Toimisto ja laboratorio  
Lepolantie 5  
FIN-03600 Karkkila  
Finland

☎ (09) 2252 860  
fax (09) 2252 8660  
www.novalab.fi

Pankki  
Länsi-Uudenmaan Op  
Karkkila  
529728-2716

Y-tunnus 0733227-8  
Kotipaikka Karkkila  
Alv.rek.

Appendix 5.

**Data of dry fermentation plants on-farm**

		Concrete or steel container	Plastic bag		Dome reactor	Foil cover	Container module	Container module	Anacom	Järna	Järna
		(Kuusinen & Valo 1987)	(Linke et al. 2002)		(Mumme 2003)	(Schulze 2005)	(Kusch et al. 2005)	(Gronauer & Aschmann 2004)	(Baserga et al. 1994)	average	maximum
Volume	m <sup>3</sup>	100,0	246,2	226,2	7,5	20,0	514,8	112,0	9,6	90,0	90,0
Working volume	m <sup>3</sup>	80,0	472,3		7,0	20,0	420,0	40,0	5,6	70,6	70,6
Input		pig manure turnip rape straw wheat straw	48% farm yard manure	26% farm yard manure	85% beef manure 15% grass silage	10 t corn silage 0.2% inoculum 600 kg	75% green cuttings	40% green cuttings	beef manure 2.5-3 kg straw	dairy manure straw oat husk	dairy manure straw oat husk
			18% green cuttings	24% fresh manure			25% Inoculum 400-440 kg	60% inoculum			
			16% corn silage	10% green cuttings							
			4% grass	23% corn silage							
			14% potato residues	2% grass							
				15% potato residues							
FM/reactor	t	36.9	160.0	147.0	2.9	10.6	252.0	33.5	5.6	52.8	44.0
Retention time	d	120	40	26	100	99	72	64.00	28.00	22.00	22.00
FM	kg d <sup>-1</sup>	307	4000	5654	29	107	3500	523	200	2400	2000
Density	kg m <sup>3</sup>	460.9	650.0	650.0	386.7	530.0	600.0	837.5	1.0	989.0	989.0
TS	kg	5981.0	43809.5	40250.0	812.0	3593.4	116676.0	9796.0	994.0	9187.2	7656.0
TS	% FM	16.2 %	27.4 %	27.4 %	28.0 %	33.9 %	46.3 %	29.2 %	17.8 %	17.4 %	17.4 %
VS	kg	5391.0	36800.0	33810.0	682.1	3464.0	72072.0	6007.0	847.9	8184.0	6820.0
VS	% of TS	90.1 %	84.0 %	84.0 %	84.0 %	96.4 %	61.7 %	61.3 %	81.5 %	89.1 %	89.1 %
VS	% of FM	14.6 %	23.0 %	23.0 %	23.5 %	32.7 %	28.6 %	17.9 %	15.1 %	15.5 %	15.5 %

		Concrete or steel container	Plastic bag		Dome reactor	Foil cover	Container module	Container module	Anacom	Järna	Järna
Volume efficiency	kg VS m <sup>3</sup> d <sup>-1</sup>	0.4	3.7	5.8	0.9	1.7	1.9	0.8	3.2	4.1	3.4
Effective volume efficiency	kg VS m <sup>3</sup> d <sup>-1</sup>	0.6	3.7	5.8	1.0	1.7	2.4	2.3	5.4	5.3	4.4
Temperature	°C	35			35			28-38	32	38	38
Energy	kWh	3000.0				350.0		2494.1	30.6	5236.0	5236.0
	%	45.5 %	<30%			16.9 %		42.7 %	20.0 %	76.3 %	43.8 %
Yield	m <sup>3</sup> biogas	1131.4	7100.0		258.0	371.0		1150.0	268.8	1144.0	1994.3
Yield	m <sup>3</sup> CH <sub>4</sub>	660.0	3905.0		154.8	207.5	3964.0	584.0	153.2	686.4	1196.6
Yield	m <sup>3</sup> CH <sub>4</sub> d <sup>-1</sup>	5.5	97.6		1.5	2.1	55.1	9.1	5.5	31.2	54.4
Yield	% CH <sub>4</sub>	58.3 %	55.0 %		60.0 %	55.0 %		50.8 %	57.0 %	60.0 %	60.0 %
Methane production	l CH <sub>4</sub> kg <sup>-1</sup> VS	122.4	55.3		227.0	107.1	55.0	97.2	180.7	83.9	160.0
Reactor productivity	l CH <sub>4</sub> m <sup>-3</sup> d <sup>-1</sup>	55.0	206.7		206.4	104.8	106.9	81.5	570.0	346.7	770.4
Reactor productivity	m <sup>3</sup> biogas m <sup>-3</sup> d <sup>-1</sup>		0.4			0.2		0.2	1.0	0.6	1.0
Cost calculation											
Capacity	m <sup>3</sup>	200	4309.8		7.5	20.0	514.8	224.00	56.00	90.0	90.0
Investment cost	€	66 667	110 352		5 000	5 000	300 000	263 472	111 360	200 000	200 000
Depreciation	a	15	10		10	10	20	20	20	20	20
Investment	€ a <sup>-1</sup> m <sup>-3</sup>	22	23		66.67	25.00	29.14	58.81	99.43	111.11	111.11
Production cost	cent m <sup>-3</sup> CH <sub>4</sub>	111	31		88	65	75	99	48	88	40

## Appendix 6.

### Data collected

<i>Sample</i>	<i>Date</i>	<i>Vakola No.</i>	<i>Novalab No.</i>	<i>Volume l</i>	<i>pH<sup>1)</sup></i>	<i>Fresh mass g</i>	<i>TS<sup>2)</sup> g</i>	<i>Ash g</i>
<i>A</i>	<i>B</i>	<i>C</i>	<i>D</i>	<i>E</i>	<i>F</i>	<i>G</i>	<i>H</i>	<i>I</i>
Solid fraction	11.5.2004	2			8,160	20,157	4,888	0,507
Solid fraction compost <sup>3)</sup>	6.5.2004	K1		50		20840,000		
Solid fraction compost <sup>3)</sup>	18.5.2004	K1				18,696	6,562	
Solid fraction compost <sup>3)</sup>	1.6.2004	K1				19,846	6,999	
Solid fraction compost <sup>3)</sup>	22.6.2004	K1				11,122	4,825	0,629
Solid fraction compost <sup>3)</sup>	17.8.2004	K1	1		8,410	14,207	5,279	0,779
Solid fraction compost <sup>3)</sup>	17.8.2004	K1 <sup>4)</sup>		30		8300,000		
Solid fraction compost fresh <sup>3)</sup>	6.5.2004	K4		50		30940,000		
Solid fraction compost fresh <sup>3)</sup>	18.5.2004	K4				21,632	4,773	
Solid fraction compost fresh <sup>3)</sup>	1.6.2004	K4				20,020	4,420	
Solid fraction compost fresh <sup>3)</sup>	22.6.2004	K4				20,105	5,230	0,774
Solid fraction compost fresh <sup>3)</sup>	17.8.2004	K4	3		8,420	21,494	4,419	0,880
Solid fraction compost fresh <sup>3)</sup>	17.8.2004	K4		30		14600,000		
Solid and liquid	11.5.2004	4			8,170	20,035	2,985	0,420
Liquid fraction	11.5.2004	6			8,090	20,533	1,426	0,363
Faeces + straw + husk	11.5.2004	8			7,330	20,420	3,992	0,433
Faeces+ straw+ husk compost <sup>3)</sup>	6.5.2004	K2		50		42120,000		
Faeces+ straw+ husk compost <sup>3)</sup>	18.5.2004	K2				20,023	4,265	
Faeces+ straw+ husk compost <sup>3)</sup>	1.6.2004	K2				21,718	4,277	
Faeces+ straw+ husk compost <sup>3)</sup>	22.6.2004	K2				25,469	5,297	0,756
Faeces+ straw+ husk compost <sup>3)</sup>	17.8.2004	K2+K3	2		8,460	23,991	5,416	1,019
Faeces+ straw+ husk compost <sup>3)</sup>	17.8.2004	K2		30	0,000	17200,000		
Faeces+ straw+ husk compost <sup>3)</sup>	6.5.2004	K3		50		41320,000		
Faeces+ straw+ husk compost <sup>3)</sup>	18.5.2004	K3				16,704	3,593	
Faeces+ straw+ husk compost <sup>3)</sup>	1.6.2004	K3				19,540	4,094	
Faeces+ straw+ husk compost <sup>3)</sup>	22.6.2004	K3				28,478	5,952	0,849
Faeces+ straw+ husk compost <sup>3)</sup>	17.8.2004	K2+K3	2		8,460	23,991	5,416	1,019
Faeces+ straw+ husk compost <sup>3)</sup>	17.8.2006	K3		30		19160,000		
Effluent	11.5.2004	10			8,620	20,665	1,115	0,329
Husk	6.5.2004	11		barrow		64120,000		
Husk	22.6.2004	13	7			17,176	15,839	1,330
Straw	6.5.2004	12	6	barrow		13320,000		

<sup>1)</sup>sample is diluted with water (1:2,5), left overnight and measured

<sup>2)</sup>105°C, 20h SFS 5542

<sup>3)</sup>Composting period 10.5.2004 - 13.8.2004. Mixing 14.5., 19.5., 31.5.11.6.8.7.2004.

<sup>4)</sup>24.6.2004 3 dl water was added, 2.7.2004 1 l water was added

<i>Sample</i>	<i>Date</i>	<i>Vakola No.</i>	<i>Mass</i>	<i>Volume l</i>	<i>pH</i>	<i>Fresh mass g</i>	<i>TS g</i>	<i>Ash g</i>
<i>A</i>	<i>B</i>	<i>C</i>	<i>kg</i>	<i>E</i>	<i>F</i>	<i>G</i>	<i>H</i>	<i>I</i>
Faeces+straw+husk	29.10.2004	M13			6,99	23,688	4,262	0,46
Faeces+straw+husk	29.10.2004	M14			7,00	20,638	3,664	0,4
Faeces+straw+husk	29.10.2004	M15			6,89	25,729	4,530	0,44
Solid fraction	29.10.2004	D17			8,15	19,041	5,073	0,430
Solid fraction	29.10.2004	D18			8,25	22,383	5,097	0,493
Solid fraction	29.10.2004	D19			8,26	21,396	5,212	0,508
Liquid fraction	29.10.2004	L21			8,24	20,533	1,112	0,31
Effluent	29.10.2004	E23			8,66	21,986	0,821	0,270
Wheat straw	29.10.2004	S25	57,570			1,400	0,985	0,14
Husk	29.10.2004	H27	197,53			19,55	17,75	
Faeces+straw+husk compost								
Faeces+straw+husk compost			46,900				4,292	
		K9				23,772		
	29.10.2004			50				
Solid fraction compost			23,500				5,624	
		K10				23,732		
		K7						
Faeces+straw+husk compost	16.3.2005	K9			9,060	18,140	5,831	1,442
Solid fraction compost	16.3.2005	K6			8,830	13,273	8,063	1,369
Solid fraction compost	16.3.2005	K8			8,780	14,773	6,353	1,161
Solid fraction compost	16.3.2005	K10			8,840	11,880	7,053	1,231



## Appendix 7.

### Mass balance

For the calculation of biogas mass we used following figures:  $\rho_C = 1.977 \text{ kg m}^{-3}$ , the  $\rho_A = 0.717 \text{ kg m}^{-3}$ , and  $\rho_W = 0.804 \text{ kg m}^{-3}$ , valid at  $0^\circ\text{C}$  and  $1.0132 \text{ bar}$  barometric pressure (Brockmann, 1987). Because the carbon dioxide measurement was done only once we use for  $c_1 = 40 \%$  and for  $c_1 = 32 \%$ . Vapour content is assumed to be 3 volume % of the biogas.

$$G_1 = A_1 + C_1 + W_1 \text{ or}$$

$$B_1 = A_1 \cdot \rho_A + C_1 \cdot \rho_C + W_1 \cdot \rho_W \text{ and}$$

$$A_1 = G_1 - G_1 \cdot c_1 - G_1 \cdot 0.03 \text{ or } A_1 = G_1 \cdot (0.97 - c_1)$$

$$B_1 = G_1 \cdot (0.97 - c_1) \cdot \rho_A + G_1 \cdot c_1 \cdot \rho_C + G_1 \cdot 0.03 \cdot \rho_W$$

$$B_1 = G_1 \cdot ((0.97 - c_1) \cdot \rho_A + c_1 \cdot \rho_C + 0.03 \cdot \rho_W)$$

$$B_2 = G_2 \cdot ((0.97 - c_2) \cdot \rho_A + c_2 \cdot \rho_C + 0.03 \cdot \rho_W)$$

$$B = G_1 \cdot ((1 - w - c_1) \cdot \rho_A + c_1 \cdot \rho_C + w \cdot \rho_W) + G_2 \cdot ((1 - w - c_2) \cdot \rho_A + c_2 \cdot \rho_C + w \cdot \rho_W)$$

$$B = G_1 \cdot \rho_A - G_1 \cdot \rho_A \cdot w - G_1 \cdot \rho_A \cdot c_1 + G_1 \cdot c_1 \cdot \rho_C + G_1 \cdot w \cdot \rho_W +$$

$$G_2 \cdot \rho_A - G_2 \cdot \rho_A \cdot w - G_2 \cdot \rho_A \cdot c_2 + G_2 \cdot c_2 \cdot \rho_C + G_2 \cdot w \cdot \rho_W$$

$$B = G_1 \cdot ((\rho_A \cdot (1 - w - c_1)) + c_1 \cdot \rho_C + w \cdot \rho_W)$$

$$B_1 = G_1 \cdot ((0.97 - c_1) \cdot 0.717 + c_1 \cdot 1.977 + 0.03 \cdot 0.804)$$

$$B_1 = G_1 \cdot ((0.97 - c_1) \cdot 0.717 + c_1 \cdot 1.977 + 0.02412)$$

$$B_1 = G_1 \cdot (0.69549 - c_1 \cdot 0.717 + c_1 \cdot 1.977 + 0.02412)$$

$$B_1 = G_1 \cdot (0.71961 + c_1 \cdot 1.26)$$

$$B_2 = G_2 \cdot (0.71961 + c_2 \cdot 1.26)$$

$$B = B_1 + B_2 = G_1 \cdot (0.71961 + c_1 \cdot 1.26) + G_2 \cdot (0.71961 + c_2 \cdot 1.26)$$

$$B = G_1 \cdot (0.71961 + c_1 \cdot 1.26) + G_2 \cdot (0.71961 + c_2 \cdot 1.26)$$

$$B = G_1 \cdot 1.22361 + G_2 \cdot 1.12281$$

$$C = G_1 \cdot c_1 \cdot \rho_C + G_2 \cdot c_2 \cdot \rho_C$$

$$C = G_1 \cdot 0.7908 + G_2 \cdot 0.63264$$

$$A = \rho_A \cdot (G_1 \cdot (0.97 - c_1) + G_2 \cdot (0.97 - c_2))$$

$$A = G_1 \cdot 0.40869 + G_2 \cdot 0.46605$$

Appendix 8.

## Calculation of the reactor capacity

Reactor Data			
<i>Reactor 1</i>			
Diameter		2.850	m
Height		10.500	m <sup>3</sup>
Inside volume of reactor	A	66.984	
Volume of top void	B	10.093	
Area of heater pipe		0.193	m
Length of heater pipe		20.386	m <sup>3</sup>
Volume of heater pipe	C	3.943	
Area of feeding pipe		0.126	m
Length of feeding pipe		10.000	m
Volume of feeding pipe	D	1.257	
<b>Effective volume of reactor 1: V=A-B-C</b>	<b>V</b>	<b>52.948</b>	<b>m<sup>3</sup></b>
<i>Filter</i>			
Diameter		0.150	m
Height		0.050	m
Volume of corners	min	0.001	m <sup>3</sup>
	max	0.003	m <sup>3</sup>
Volume (with voids)		65.000	ml
<i>Reactor 2</i>			
Diameter		2.850	m
Height		4.000	m
Inside volume of reactor	A	25.518	m <sup>3</sup>
Top void		0.700	m
Bottom void		0.500	m
Total void		1.200	m
Volume of void	B	7.655	m <sup>3</sup>
Volume occupied by heater pipe 80mm, 6 time coil	C	0.265	m <sup>3</sup>
<b>Effective volume of reactor 2: V=A-B-C</b>	<b>V</b>	<b>17.597</b>	<b>m<sup>3</sup></b>
Number of filters occupying the reactor	min	15641	
	max	5213	
Total volume of filter	min	0.339	m <sup>3</sup>
	max	1.017	m <sup>3</sup>
Volume occupied by effluent	V <sub>min</sub>	16.580	m <sup>3</sup>
	V <sub>max</sub>	17.258	m <sup>3</sup>
	V <sub>mean</sub>	16.919	m <sup>3</sup>

## **Agricultural Engineering reports published in Agrifood Research Reports series.**

- 77 Dry anaerobic digestion of organic residues on-farm - a feasibility study. *Schäfer et al.* 98 p.
- 71 Group management of young dairy cattle in relation to animal behaviour and welfare. *Raussi.* 86 p. 4 appendices.
- 62 Maidon laatu, eläinten utareterveys, käyttäytyminen ja hyvinvointi automaattilypsyssä. *Suokannas ym.,* 97 s.
- 44 Laajamittaisen luomutuotannon teknologia – taloudellinen toteutettavuus ja ekologinen kestävyys. *Lötjönen ym.,* 139 s.
- 40 Kokoviljasäilörehu viljatilalla. *Suokannas ym.,* 77 s.
- 39 Occupational Accidents in Finnish Agriculture - Causality and Managerial Aspects for Prevention. *Suutarinen.* 75 s. 5 appendices.
- 31 Viljan korjuu ja varastointi laajenevalla viljatilalla. *Suomi ym.* 106 s.
- 21 Luomusikala Suomen olosuhteissa. *Kivinen.* 78 s.
- 18 Ajettavien työkoneiden kulkuteiden turvallisuus II. *Suutarinen ym.* 95 s.
- 6 Työsuojelupanostuksen kannattavuus maataloudessa. *Suutarinen ym.* 87 s.
- 4 Digitaalikuvausten ja vesiherkän paperin käyttö perunan ruiskutus-tutkimuksessa. *Suomi & Haapala.* 77 s.

