



VAKOLA



Rukkila
Helsinki 100



Helsinki 43 41 61



Pitäjänmäki

VALTION MAATALOUSKONEIDEN TUTKIMUSLAITOS
Finnish Research Institute of Engineering in Agriculture and Forestry

1971

Study report

9

Tutkimusselostus

**EXPERIMENT FOR DEVELOPING A METHOD
HOW TO MEASURE AND EVALUATE THE
ROCKING OF THE FOREST TRACTOR**

KAUKO AHO — JUHA KÄTTÖ

SUOMENKIELINEN TIIVISTELMÄ:
TUTKIMUS METSÄTRAKTORIN HEILUMISEN MITTAUS- JA ARVOSTELUMENETELMÄN
KEHITTÄMISEKSI

HELSINKI 1971

S U M M A R Y

The mechanical vibration applying to the forest tractor driver may have drawbacks from increasing fatigue up to immediate injury of certain organs.

This experiment has been made (a) in order to find out the vibration, which occurs in practical forest work, (b) to clear up the highest tolerable running speeds and, (c) to develop a method for comparing the rocking properties of tractors. Seven forest tractors have been along in this experiment. Three of them were skidders: Michigan Clark Ranger 666, Juonto-Lokkeri, and Valmet 880; three others were forwarders: Teli-Lokkeri, BM-Volvo SM 868, and Valmet BK-LM, which was measured only on the obstacle proving track of the Finnish Research Institute of Engineering in Agriculture and Forestry; and BM-Volvo SM 661, which is equipped with 3/4 -tracks and draws its load with a trailer.

In addition to the theoretical examination based on the features of the tractors, also accelerations caused by vertical and lateral rocking of the body of unloaded tractors, and the vertical rocking of the driver have been measured on terrain tracks of various stages, on a fairly good forest road, on a gravel road, and on the obstacle proving track of the Institute.

The tracks have been described by computing the mean-square spectral densities of the tracks' profile frequency.

The measurement results have been evaluated on the basis of the proposal of the I.S.O. working group ISO/TC 108/WG 7 N 36. Supposing rocking, which the driver is able to stand 2,5 hours per day (the 2,5 hours' »Exposure Limit»), the running speed had to be 26 . . . 36 per cent slower on the most difficult terrain track than on the easiest one. When speeding up so that the rocking corresponded one hour's safe ride a day the corresponding differences varied 17 . . . 37 per cent. The difference between the tractors on the terrain tracks, was (39 . . . 41 per cent) greater when driving at the speed corresponding the 2,5 hours' »Exposure Limit» than at the speed that corresponds the one hour »Exposure Limit», when the velocities differed 12 . . . 21 per cent. In terrain the velocity cannot, in general, exceed 1 m/s when driving an unloaded tractor.

Rocking becomes most serious when driving on a fairly good forest road. Then the tractor body or the seat or both of them easily falls into

resonance with excitation caused by the unevenities of the road. The velocity is not in general able to exceed 3 m/s. The rocking can easily exceed even the one minute »Exposure Limit».

On true country road rocking is not generally intensive.

On a difficult terrain the operator takes good care of not letting the load fall and drives at a rather moderate speed. This is also due to the very sharp strengthening of the rocking when increasing the speed. When the terrain or the road gets better the driver usually starts driving too fast.

The seats tested were hardly applicable for forest tractors, and in general, they at least at some practical frequency range increased the rocking between the body of the tractor and the driver.

As to the rocking, placing the seat on the wheel base and the engine in front are advantageous decisions.

The tandem axle in the rear together with the pendulum axle in the front essentially reduces the lateral rocking.

Finally we have presented the measurement procedure and the permanent test tracks corresponding forest road and terrain, for measuring and evaluating the rocking characteristics of forest tractors.

T I I V I S T E L M Ä

Metsätraktorin kuljettajaan kohdistuvalla mekaanisella värähtelyllä saattaa olla haittavaikutuksia ylimääräisestä väsymisestä välittömään elimelliseen vaurioitumiseen saakka.

Tämä tutkimus on tehty a) nykyisessä käytännön työssä ilmenevän värähtelyn toteamiseksi, b) suurimpien siedettävien ajonopeuksien selvittämiseksi sekä c) menetelmän kehittämiseksi traktorien heilumisominaisuuksien vertailemiseksi. Tutkimuksessa on ollut mukana seitsemän metsätraktoria. Kolme niistä oli vetotraktoreita, Michigan Clark Ranger 666, Juonto-Lokkeri ja Valmet 880, kolme kuormatraktoria, Teli-Lokkeri, BM-Volvo SM 868 ja Valmet BK-LM, jota mitattiin vain maatalouskoneiden tutkimuslaitoksen esteradalla, sekä BM-Volvo SM 661, joka on 3/4-telaketjuilla varustettu ja vetää kuormaansa perävaunulla.

Traktoreiden päämittojen perusteella tehtyjen teoreettisten tarkastelujen ohella on mitattu kuormittamattomien traktoreiden rungon pystysuoran ja vaakasuoran poikittaisen heilunnan sekä traktorin kuljettajan pystysuoran heilunnan aiheuttamia kiihtyvyyksiä eri asteisilla metsämaastoradoilla, hyvänlaisella metsäautotiellä, sorapäällysteisellä maantiellä sekä maatalouskoneiden tutkimuslaitoksen esteradalla.

Radat on kuvattu laskemalla ratojen profiilien epätasaisuuksien tehospektriitheydet.

Mittaustuloksia on arvosteltu ISO:n asettaman työryhmän ISO/TC 108/WG 7 N 36:n suositusehdotuksen perusteella. Rajoittamalla heilunta sellaiseksi, jota kuljettaja kestää 2,5 tuntia päivässä, jouduttiin vaikeimmalla maastoradalla ajamaan 26 . . . 36 % hitaammin kuin helpoimmalla maastoradalla. Lisättäessä nopeutta niin, että heilunta vastasi yhden tunnin vaaratonta ajoa päivässä vastaavat erot vaihtelivat 17 . . . 37 %. Eri traktoreiden välinen ero maastoradoilla oli suurempi (39 . . . 41 %) ajettaessa 2,5 tunnin vaararajaa vastaavalla nopeudella kuin 1 tunnin vaararajaa vastaten, jolloin ajonopeuksissa oli eroa 12 . . . 21 %. Ajettaessa kuormittamattomilla traktoreilla maastossa ajonopeus ei yleensä voi olla yli 1 m/s.

Suurimmaksi heilunnan aiheuttama vaara muodostuu ajettaessa verrattain hyväkuntoista metsätietä. Tällöin traktori, ajajan istuin tai molemmat joutuvat helposti resonanssiin tien epätasaisuudesta aiheutuvan heijastuksen kanssa. Nopeus ei saa yleensä ylittää 3 m/s. Heilunta saattaa helposti ylittää 1 min vaararajan.

Varsinaisella maantiellä heilunta ei yleensä ole voimakasta.

Vaikeassa maastossa kuljettaja varoo kuorman kaatumista ja ajaa verrattain kohtuullista vauhtia. Tämä johtuu myös heilunnan hyvin jyrkästä voimistumisesta vauhtia lisättäessä. Maaston ja ajoradan parantuessa ajaja lisää yleensä liikaa ajonopeutta.

Tutkimuksessa mukana olleet istuimet olivat metsätraktoreihin huonosti sopivia vahvistaen yleensä ainakin jollakin käytännön taajuusalueella heiluntaa traktorin ja ajajan välillä.

Istuimen sijoittaminen akselivälille ja moottorin sijoittaminen etumaiseksi ovat heilunnan kannalta edullisia ratkaisuja.

Teliakselisto takana yhdessä edessä olevan heiluriakselin kanssa vähentää oleellisesti sivuttaisheiluntaa.

Lopuksi on esitetty mittausmenetelmä ja metsätietä sekä metsämaastoa vastaavat pysyvät koeradat metsätraktoreiden heilunnan mittaamiseksi ja arvostelemiseksi.

Foreword

The experiment belongs to the research project »Man and Machine», which is part of the Nordic collaboration in logging research. A Norwegian periodical, *Tidsskrift for Skogbruk* 1/1970 had a report »Från värdering av skakning på skogstraktoren» on the preliminary stage of this experiment.

In the experiment we have by several test run recordings cleared up the rocking of a tractor, due to the unevenities on the track when riding on different terrain tracks and roads. The unevenity of the tracks' profiles has been defined by computing the mean-square spectral density. On the basis of the results and the experience gained from the experiment, we have prepared a proposal for a method of measuring the rocking of the forest tractor.

The experiment was made at Enso-Gutzeit Ltd. Educational Center, Pamilo Eno, in the summer of 1970. Mr. K. Rantapuu and Mr. P. Hars-tela, researchers at the Forest Research Institute in Finland, chose the test tracks and assisted in the practical measurement arrangements. Enso-Gutzeit Ltd. gave us the tractors for the experiment free of charge. We also received some help from the Pamilo Ltd. for setting up the measuring equipments.

The first analysis of the results was made by Mr. J. Kättö so getting there by also the main data for his »diploma» -work: »The effect of the construction of a forest tractor on the rocking of the operator and the load». He has also drawn the figures in this paper.

The report has been translated into English by Miss Leena Aho.

The paying for the assistants within this experiment, and other occatio-nal expences have been taken care by the fund of the Nordic collaboration in logging research.

Helsinki, September 1971

Kauko Aho

Juha Kättö

CONTENTS

	Page
Summary	2
Tiivistelmä	3
Foreword	5
Contents	6
1. Introduction	7
2. General Consideration	8
3. Factors That Affect Vibration	8
3.1. Track	9
3.2. Effect of Tractor Construction	12
3.3. Seat	17
4. Rocking Measurement	17
5. Tracks Used	19
6. Measurement Results	22
7. Conclusion	26
7.1. The Character of the Vibration on Different Tracks	26
7.2. The Speeds Used and the Tolerable Speeds	27
7.3. Tractor's Structural Effect on Results	28
8. Proposal for a Method of Measuring the Rocking Behavior of a Forest Tractor	28
8.1. General	28
8.2. Measuring Procedure	28
8.3. Evaluation of the Results	29
References	30
Appendix	31

1. Introduction

Mechanical vibration, which applies to the forest tractor driver, has a wide variety of effects from increased fatigue to insecure application of controlling devices and to a gradual or even an immediate injury of the body. In order to reduce the harmful influence they have in recent years tried by various means to improve the construction of a tractor.

To find out the tractor's response to the roughness of the ground, and to follow the development of the improvements, measurements have to be made in such similar circumstances that a comparison is possible. For the evaluation of the measurement results, it is necessary to have information on (1) the effect of various vibrations on human body, (2) the time-history of the daily exposure, and (3) also a description of the features of the test tracks and terrain surface in practice.

Vibration, as it own, is a phenomenon, whose features in order to be determined, demand several parameters:

- (1) Exposure area (whole body or e.g. only hands or feet)
- (2) Exposure direction
- (3) Frequency or frequency ranges
- (4) Intensity of vibration (acceleration, velocity or displacement)
- (5) Variation of intensity and frequency during the exposure
- (6) Exposure time

Forest tractor driver becomes in his work the object of a strong vibration and rocking. In particular in terrain, but also on rather good forest roads the rocking caused by the unevenities of the surface of the track, is so intensive that the speed has to be sharply limited.

This present experiment has been made, first, to clear up the features and the reasons of the vibration which is caused by the undulation of the ground and which expose man, second, to develop a method for measuring and comparing the vibration properties of different forest tractors.

In literature there are described a few measurements concerning agricultural tractors on field and on different kinds of roads (BJERNINGER, 1966, DUPUIS, 1963, 1964 and 1965, LOUDA, 1970, MORRISON & HARRINGTON, 1962, and SJÖFLOT, 1968).

Forest tractors, which are a lot larger than agricultural tractors and which have to move on considerably uneven terrain, have not been experimented in this aspect. The experiments mentioned before are also

lacking a precise description of geometrical terrain values. In forest terrain the unevenness of the surface varies so much that giving out the results without a description of the terrain would be senseless. Even though the results also then represent only one certain case, a possibility for comparison always exists.

The actual field experiment was made on the terrain of Enso-Gutzeit Ltd. Educational Center, Pamilo, Eno. Three skidders: Valmet 880, Michigan Clark Ranger 666, and Juonto-Lokkeri; and three forwarders: BM-Volvo SM 858, BM-Volvo SM 661, and Teli-Lokkeri, were tested.

2. General Consideration

Rocking has been found to influence vehicle and especially terrain and earth moving tractor drivers by means of increased fatigue and decrease of working efficiency, but also direct decrease of safety and health. Because this kind of a vibration phenomenon is a many-sided problem, the human tolerance is very hard to be determined. In order to facilitate the evaluation and comparison of the data gained on whole body vibration, the I.S.O. working group ISO/TC 108/WG 7 N 36, under the International Organization for Standardization, has prepared a Proposal for I.S.O. Recommendation (1970). In this Proposal some provisional guidance as to acceptable human exposure to vibration is also given.

In the proposal three criteria have been given for human response to vibration:

- (1) the preservation of comfort
- (2) the preservation of working efficiency
- (3) the preservation of health and safety

According to this, three boundaries have been named:

- (1) Reduced Comfort Boundary
- (2) Fatigue—Decreased Proficiency Boundary
- (3) Exposure Limit

If then it is e.g. important to maintain the attention and working efficiency of the driver as good as possible, the »Fatigue—Decreased Proficiency Boundary» would be used as a guiding limit. We ought to keep in mind that this Proposal only applies to people in normal health.

3. Factors That Affect Vibration

Vibration environment of a tractor operator is affected by:

- roughness of track
- running speed
- construction of vehicle

3.1. Track

A forest tractor is capable for off-the-road locomotion. In this connection even a single passed terrain is called a track.

In order not to leave the results of the experiment as only some unprecise samples, the mean-square spectral density of the track's profile (power spectral density) has been measured and computed, Ано (1969). This way of expressing has been developed to describe the random functions. If a continuous sample $f(x)$ were taken from the vertical change of the track's profile, the power spectral density would be determined by the following Formula (1):

$$\Phi(\Omega) = \lim_{x \rightarrow \infty} \frac{1}{2\pi X} \left[\int_{-X}^{+X} f(x) e^{-i\Omega x} dx \right]^2 \quad (1)$$

where Ω = track's profile frequency, spatial frequency (rad/m), and X = half of the length of the examined track (m)

As the profile of the track was not examined as a continuous function, but by taking samples at equal space in digital form, the power spectral density could not be computed from the Formula (1), but from the Formula (2), which is expressed in a form of a limited sum:

$$\Phi(\Omega) = \frac{1}{2\pi N\Delta x} \left| \sum_{n=0}^N \left[f(x_n) - f_m(x_n) \right] e^{-i\Omega x_n \Delta x} \right|^2 \quad (2)$$

where $N\Delta x = X$
 $n\Delta x = x_n$

$$f_m(x_n) = f(x_0) + \frac{f(x_1) - f(x_0)}{l} x_n \quad (3)$$

The track is divided so that when the inclination of the track changes another part begins. Consequently the distances l , are chosen so that the true inclination of the parts of the track remains the same and so cannot affect the result. The vertical deviations are calculated according to the Formulas (2) and (3), from the average at the respective point of the track. The power spectral density of the whole track is obtained from the average of the spectra. Simultaneously a picture of the stationarity of the track is reserved.

The distance Δx between the samples may, at the most, be a half of the length of the shortest interesting undulation. This shortest

undulation depends on the natural frequency of the tractor and the velocity as follows:

$$2 \Delta x = \frac{v}{f_0}$$

where v = velocity (m/s), and

f_0 = tractor's natural frequency when it is vibrating up and down on pneumatic tires (Hz)

In practice, the velocity may go down till about 0,5 m/s, and $f_0 = 2$ Hz. Thus the length of the shortest interesting wave observed, is 0,25 m and the distance between the samples taken 0,125 m.

Due to such a slow speed and the elasticity and plasticity of the tires and the ground, the acceleration of the tractor caused by small unevenities is minor. When driving in terrain the rocking is most often due to bumping against individual obstacles, after which the tractor continues vibrating at its natural frequency. The intensity of the vibration depends on the strength of the bump, or in other words on the height of the obstacle and the velocity.

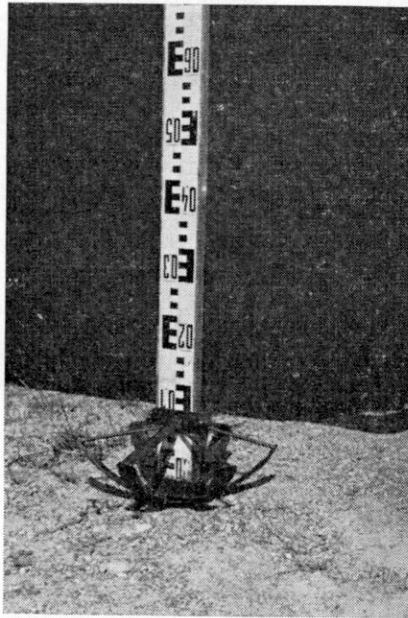

Figure 1. A stick used for measuring the profile of the tracks.

On terrain tracks the samples were taken every 30 cm and on roads every 15 cm. Thus on terrain tracks a picture was obtained of 60 cm longer and on roads of 30 cm longer undulation. The profile of the track was measured along a line marked with a rope. At certain distances there were marking strips in this rope. A measuring stick having a spherical base 30 cm in diameter (Fig. 1) was used. The vertical position of the stick in regard to horizontal O-level was read from a theodolite.

The power spectral density of the track's profile was not calculated directly from the formula (2), but it was easier to achieve the same result by using the autocovariance function of the terrain profile

$$R_r = \frac{1}{2N-r} \sum_{p=1}^{2N-r} \bar{f}(x=p) \bar{f}(x=p+r) \quad (5)$$

where $\bar{f}(x) = f(x) - f_m(x)$,

$r = 0, 1, 2, \dots, m$, and

$2N =$ number of measuring points at the distance l

The number of the autocovariance factors m , is taken so large that even the longest waves, which are of any importance as far as the rocking of a tractor is concerned, can be taken into account. The Fourier-transforms of the autocovariance factors from the periodic function represent the power spectral densities Φ'_r at definite frequency ranges.

$$\Phi'_r(\Omega) = \frac{\Delta x}{\pi} \left(R_0 + 2 \sum_{q=1}^{m-1} R_q \cos \frac{qr\pi}{m} + R_m \cos r\pi \right) \quad (6)$$

The values of Φ'_r include the side lobes due to the way of computing.

These side lobes can be eliminated, in the following way, while the function will also be smoothed.

$$\left. \begin{aligned} \Phi_0 &= 0,54 \Phi'_0 + 0,46 \Phi'_1 \\ \Phi_r &= 0,23 \Phi'_{r-1} + 0,54 \Phi'_r + 0,23 \Phi'_{r+1} \\ \Phi_m &= 0,46 \Phi'_{m-1} + 0,54 \Phi'_m \end{aligned} \right\} \quad (7)$$

The frequency range of the roughness $\Delta\Omega$ is defined in equation (8):

$$\frac{(r-1)\pi}{m \Delta x} \leq \Delta\Omega_r \leq \frac{(r+1)\pi}{m \Delta x} \quad (8)$$

Ω_r is given in radians per meter. By dividing Ω by 2π you get the number of waves per meter F , whose reciprocal is the wave length λ (m).

The power spectral density of the profile frequency can at least approximately be represented on log-log paper by a straight line

$$\left. \begin{aligned} \log \Phi (F) &= a \log F + b \\ \Phi (F) &= 10^b F^a \end{aligned} \right\} \quad (9)$$

In the equation (9) a stands for the slope of the line concerned, and b the value of the log of the power spectral density when the length of the wave is 1 m. Such a way of presentation eventhough it is approximal facilitates the comparison of the tracks.

When the profile frequency is Ω , exciting frequency, which depends on time (running velocity), is obtained through the formula (10), where the running velocity is v (m/s):

$$\omega = v\Omega \quad (10)$$

The intensity of the exciting function depends on track's power spectral density and running velocity as follows:

$$\Phi (\omega) = \frac{1}{v} \Phi (\Omega) \quad (11)$$

3.2. Effect of Tractor Construction

BOGDANOFF and KOZIN (1960, 1961, and 1963) have made theoretical investigations on the influence of the length of the wheel base on vertical accelerations and pitching for a given random terrain. They found out that extending the wheel base over 5 meters didn't have a reducing effect on this acceleration any more.

The rocking of the tractor is of course also affected by the way of suspending the wheels. The tandem wheel construction effectively reduces

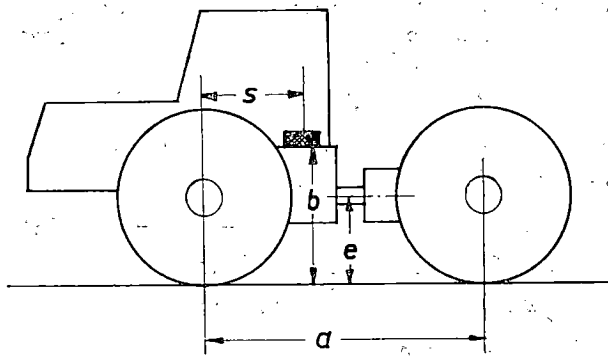

Figure 2. The main dimensions of a forest tractor for static examination.

both the vertical and lateral rocking. By using at the same time a pendulum type of a front axle, the lateral rocking can be limited to a very minor amount.

When observing a loaded tractor moving in terrain it can often be considered as an almost static phenomenon. Then the movements of the point examined can be calculated as follows:

(a) Obstacle under the wheel fixed to the pendulum axle (Fig. 2) Vertical move z_h

$$z_h \approx \frac{s}{a} \left[\sqrt{\left(\frac{r_h}{2}\right)^2 + e^2} \sin(\alpha_1 + \beta_1) - e \right] \quad (12)$$

Lateral move y_h

$$y_h \approx \frac{s}{a} \left[\frac{r_h}{2} - \sqrt{\left(\frac{r_h}{2}\right)^2 + e^2} \cos(\alpha_1 + \beta_1) \right] \quad (13)$$

$$\sin \alpha_1 = \frac{b}{r_h}, \quad \tan \beta_1 = \frac{2e}{r_h}$$

where b = height of obstacle

s = horizontal distance of the point examined from the axle, which is in a firm connection with the cab; s is negative if the point is in the opposite direction from the firm axle than in Figure 2.

r_h = wheel track on the pendulum axle

(b) Obstacle under the wheel in a firm connection with the cab (Fig. 2)

Vertical move z_k

$$z_k \approx \frac{a-s}{a} \left[\sqrt{\left(\frac{r_k}{2}\right)^2 + b^2} \sin(\alpha_2 + \beta_2) - b \right] \quad (14)$$

Lateral move y_k

$$y_k \approx \frac{a-s}{a} \left[\frac{r_k}{2} - \sqrt{\left(\frac{r_k}{2}\right)^2 + b^2} \cos(\alpha_2 + \beta_2) \right] \quad (15)$$

$$\sin \alpha_2 = \frac{b}{r_k}, \quad \tan \beta_2 = \frac{2b}{r_k}$$

where r_k = wheel track on the firm axle

A graphic solution may in certain cases give a significantly more accurate result.

Table 1. The ratio of the operator's move to the obstacle height (40 cm) on the basis of the approximate static examination

Tractor	Relative move of operator % (h = 40 cm)			
	Obstacle under front wheel		Obstacle under rear wheel (only under one of the tandem wheels)	
	Vertical move	Lateral move	Vertical move	Lateral move
Clark 666	27	27	17	36
Juonto-Lokkeri	62	73	16	35
Valmet 880	25	53	19	18
BM-Volvo SM 868	41	87	0	0
BM-Volvo SM 661	0	0	43	69
Teli-Lokkeri	55	63	5	10

The results of the study of the static move of the tractors within this experiment, are shown in Table 1.

Using the static move experiment described previously it is possible to get a picture especially of the lateral rocking of the operator and the tractor. It shows the vertical moves when the velocity is slower than 1 m/s when the suspension system of the seat and the elasticity of the tires hardly affect the rocking. Sharp 30 to 40 cm high obstacles, such as stumps and trunks bumped crosswise may, however, even at this slow speed cause intolerably high accelerations, especially if the seat is mounted unfavorably (outside the wheel base).

Besides the static move experiment, e.g. the vertical rocking of the mounting point of the seat can be examined in view of dynamics. The vertical acceleration of the tractor caused by the roughness of the track, and the corresponding dynamic forces are obtained by multiplying the power spectral density value $\Phi(\omega)$ of the exciting function, which corresponds each exciting frequency ω , by the transmissibility factor of vibration system, which is characteristic of the tractor and depends on the frequency. The vibration transmissibility factor can be determined experimentally or approximately also by calculations on the basis of certain starting values.

The transmissibility factor can to certain extent be influenced by changing the inflation pressure of the tires. The loading stage of a forewarder naturally has a remarkable effect on the rocking of the tractor. The smaller the load the larger the transmissibility factor and the stronger the rocking, in particular, at the natural frequency. Consequently an empty tractor swings more than a loaded one. When using multiply rated heavy tires the swinging is remarkably worse than when soft tires are used. The damping ability of the tires, which as a matter of fact is minor, primarily affects the swinging at natural frequency.

As to the vertical rocking of a long forest tractor, the case can be simplified by thinking that the tractor consists of two vibrating one mass systems: (1) Front wheels and the mass falling on them; (2) rear wheels and the corresponding mass of the rear. The transmissibility factor V , of the acceleration amplitude of this kind of vibrating systems is obtained from the Formula (16):

$$V = \omega^2 \sqrt{\frac{1 + D^2 \eta^2}{(1 - \eta^2)^2 + 4D^2 \eta^2}} \quad (16)$$

where $D = k/k_k =$ damping ratio or ratio of the existing damping to critical damping. According to MATHEWS and TALAMO (1965) for tractor tires $D = 0.05 \dots 0.09$

$$\eta = \omega/v$$

$$v = \sqrt{\frac{c}{m}} = \text{natural frequency of vibrating system (rad/s)}$$

$$c = \text{spring rate of tires (N/m)}$$

$$m = \text{mass (kg) on tires}$$

$$\omega = \text{angular velocity of exciting function (rad/s)}$$

By calculating the combined influence of the forced vibration coming from both front and rear ends, the transmissibility factor of the vibration at different frequencies, is obtained in each desired part of the tractor. The combined influence may vary between certain maximum- and minimum values depending on the phase of the vibration coming from both ends. When the point in question, is right on the front- or rear axle the maximum- and minimum values join to one single graph.

In Figure 3, there is shown the transmissibility factor of the acceleration of the vertical swinging at the mounting point of Teli-Lokkeri's seat when the tractor is loaded with a 8 000 kg load and unloaded. In the experiment the seat is placed (a) on the present place about 1.0 m in front of the front axle, (b) on the front axle, (c) 1.0 m behind the front axle, and (d) in the middle of wheel base. The experiment has been done at the frequency range from 0 to 10 Hz. The spring rate of the tires has been taken 7 000 N/cm per tire and the damping ratio $D = 0.07$.

As in terrain the rocking of the tractor is mainly natural vibration, the transmissibility factor at the natural frequency can be considered also as an object of evaluation.¹ According to that the acceleration of the vertical rocking of an unloaded tractor on the front axle is from 15.5 to 21 per cent, and in the same way 1 m behind the axle from 17.5 to 19 per cent less than at the present place of the seat. In a loaded tractor the vertical rocking is on the front axle from 7 to 27 per cent less, and 1 m behind the axle at least 22 per cent less than at the present place.

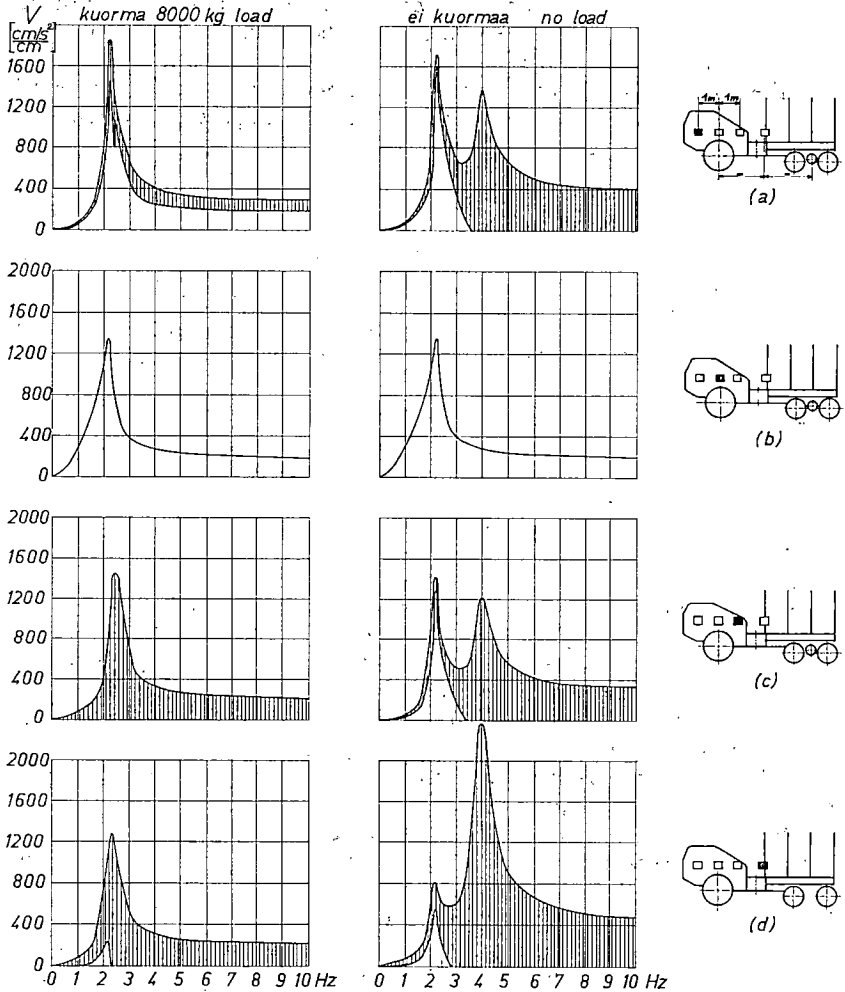

Figure 3. The transmissibility factor of the acceleration of the vertical swinging at the mounting point of Teli-Lokkeri's seat when the tractor is loaded with a 8 000 kg load and unloaded.

- The seat is (a) on the present place about 1,0 m in front of the front axle
 (b) on the front axle
 (c) 1,0 m behind the front axle
 (d) in the middle of the wheel base

For practical reasons the cab cannot be placed in middle of the wheel base. When loaded there would not be much vertical rocking, but when running unloaded the four rear wheels might cause strong shocks.

Increasing the weight of the front of the tractor would reduce the value of the transmissibility factor. Keeping this in mind a normal solution, to place the engine in front, would be better than a light front of the tractor.

The higher the cab is placed the stronger especially the lateral rocking is. On the other hand a low placed cab seems to roll more around the axle, in driving direction, especially when the obstacle hits under the wheel, which is firmly fixed to the cab part of the tractor.

3.3. Seat

The high frequency vibration of the tractor can be fairly effectively damped by the construction of the seat. While the rocking caused by the ground can be only partly damped due to the large movements. Even then only the vertical rocking becomes into question. Horizontal swinging movements and accelerations cannot be reduced with the present technique.

In order to be able to damp the natural vibration of a terrain tractor (unloaded 2...3 Hz; loaded 1.5...2 Hz), the suspension of the seat should be very soft and to prevent too large a movement progressive of its effect.

4. Rocking Measurement

To measure the rocking of the whole tractor and the operator, the measuring transducers ought to be placed e.g. to the mounting point of the seat and between the operator and the seat cushion. Thus a picture of the suspension characteristic of the seat is also obtained. To get comparable results the measurements are to be made on a permanent track, whose profile corresponds the terrain in practice. In terrain tractor the swinging is so slow that measuring the acceleration must be considered the best method both in view of measuring technique, and in view of facilitating the evaluation of the results concerning the operator.

In this experiment the acceleration was simultaneously measured at the mounting point of the seat in vertical and lateral direction, and on the operator's back in vertical direction. The necessary amplifying- and recording equipments and the current converter with accumulators were placed onto the tractor (Fig. 4).

The amplified measurement signals were registered with an instrumentation tape recorder and analysed with third octave band filters, at frequency range from 1.5 to 10 Hz. During the analysis the speed of the magnetic tape was made sixteenfold. A sample of the continuously



Figure 4. The amplifying- and register equipments of the measurement signals, on a skidder.

changing acceleration was also taken with a classifier 50 times a second when the speed of the magnetic tape stayed unchanged. RMS-value of the classified acceleration was calculated. Before classifying, the high frequency vibration, from 11 Hz on, were already filtered from the acceleration signal, because only the vibration caused by the ground was meant to be examined.

In measuring and analysing, following equipment was used:

Acceleration transducers:	2 pieces of Consolidated Electro-dynamics Corporation 4-202
	1 piece of Hottinger Baldwin Messtechnik GMBH, B1/250—5
Measuring bridge:	Hottinger Baldwin Messtechnik GMBH, KWS/T—5
Amplifier:	Bell & Howell, Datatran 1—808
Instrumentation magnetic tape recorder:	a four channel Telefunken MAS 54
Frequency analyser:	Brüel & Kjaer 2112
Classifier:	Hottinger Baldwin Messtechnik GMBH KS 10—KS 10 V

The whole measurement system was able to be calibrated by tilting the transducers 90° or 180° when the change of the registered signal corresponds 1 or 2 g's acceleration ($g = 9.81 \text{ m/s}^2$).

On the test tracks we drove at various speeds in order to throw light upon the relationship between velocity and rocking.

5. Tracks Used

In the forest terrain three tracks of different degree were chosen. Track # 1 (Fig. 5) was fairly easy, mostly driven in the winter time. On the track # 2 (Fig. 6), there were lots of stumps and rocks. The most difficult



Figure 5. The easiest terrain track # 1.



Figure 6. The terrain track # 2.

one was track # 3 (Fig. 7), on a very rocky terrain, where the ground clearance of the forest tractors was just barely sufficient. The forest road was rather good, and it seemed to be smooth. The country road, in question, was a fairly good, partly a little bit so called grooved gravel road. Besides some tractors were driven on the test track of the Finnish Research Institute in Agriculture and Forestry. The author of this report has earlier described the properties of this track, АНО (1969).



Figure 7. The most difficult terrain track # 3.

The power spectral densities of the tracks' profile, measured and calculated as described before, are shown in Figure 8. The power spectral densities of the tracks were calculated altogether in 4—6 parts, separately from the both strips. Thus a picture of also the stationarity of the tracks was obtained. In Table 2, you can see the averages of the roughness of the tracks when taking 21 sin waves of different length into account. The wave length varies equally spaced from 0.5 to 5 meters. The percentual ranges of variation, in different parts of the tracks, are also shown in this Table. The roughness of the terrain track # 2 varied the most. As to the roughness of the whole tracks, they all differed significantly from each other. The actual road tracks were smoother than the terrain tracks and even the test track of the Institute. The terrain tracks differed from each other only in regard to unevenities longer than 1.5 meters.

The constants a and b of the Formulas (9), which approximately describe the power spectral densities of the tracks' profiles $\Phi(F)$ on log-log paper, can be seen in Table 2.

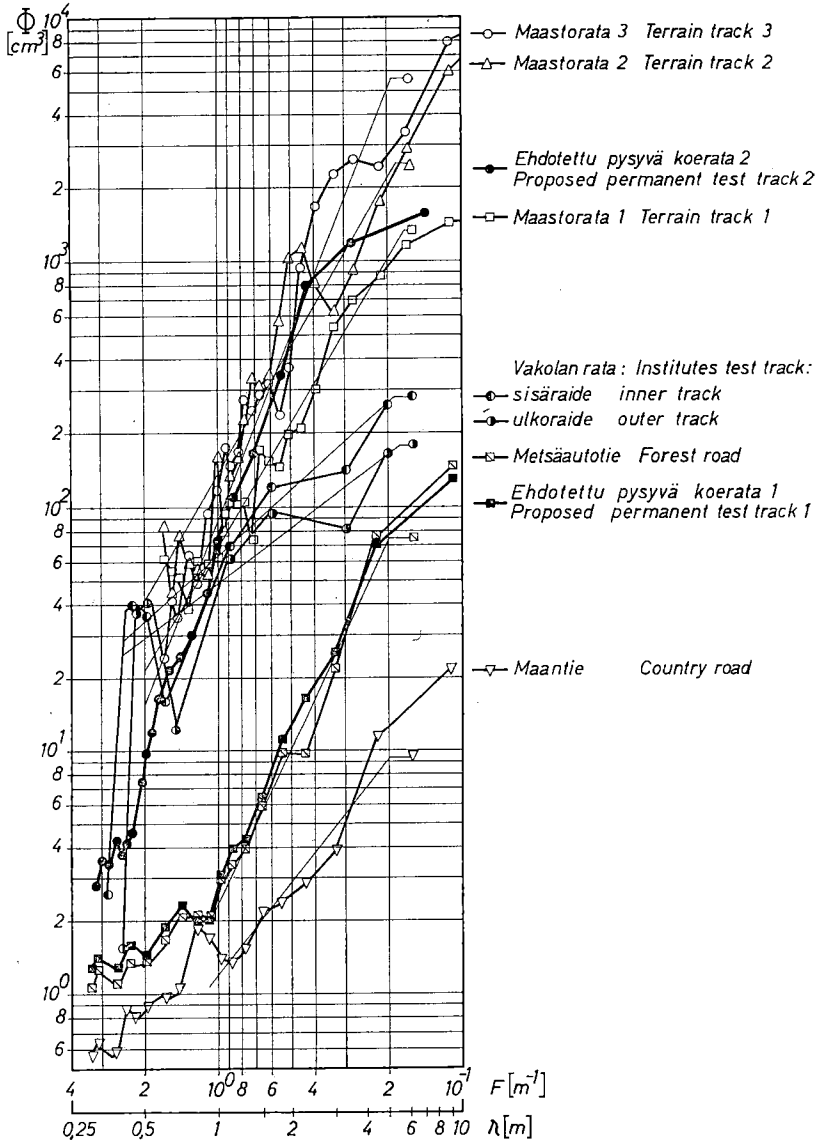

Figure 8. The mean-square spectral densities (the power spectral profiles) of the tracks' profiles within the experiment. The power spectral density of the profile of the suggested, permanent test track, which corresponds a forest terrain, has also been marked in the drawing. The profile of a forest road has been proposed for another test track.

Table 2. Constants a and b , in the equation; $\log \Phi(F) = a \log F + b$ or $\Phi(F) = 10^{bF}$; average roughness of tracks, and variation ranges, at frequency band 0.2—2.0 waves per meter; and average unevenity concerning 5 meter's wave length, $h_{RMS 5}$.

Track	Length of Track	Constants		Unevenity		$h_{RMS 5}$
				$\sqrt{\frac{3}{2} \frac{\sum_{i=0.2} \Phi(F_i) \Delta F}{n \Delta F}}$		
		a	b	Average	Ranges of Variation + . . . - %	
Country road	286	-1.36	0.08	1.3	25 . . . 14	2.2
Forest road	204	-2.14	0.38	2.1	32 . . . 24	4.2
Test track of the Institute	87.5	-1.22	1.55	5.4	—	5.9
Terrain track #1	87	-1.66	1.84	5.8	6,5 . . . 8,2	10.0
Terrain track #2	54	-1.75	2.12	7.0	59 . . . 32	12.9
Terrain track #3	54	-2.48	1.95	7.8	29 . . . 23	17.1

6. Measurement Results

A preliminary picture of the rocking of the tractor and its driver is obtained by calculating the RMS-value of the continuously changing acceleration. Another possibility is to make a frequency analysis of the variation of the acceleration and calculate the RMS-value of the changing effective acceleration amplitude, or to figure out to the height of the often appearing effective amplitudes. If the frequency analysis is made with a third octave band filter, the results can be evaluated on the basis of the proposal of the I.S.O. working group mentioned before. It is also possible to get a picture of the highest acceleration peaks and their deviations on the oscillograms by only studying the vibrations slower than a certain frequency.

In Figure 9, you can see the RMS-value of the effective vertical and lateral acceleration amplitude measured at the mounting point of the seat, and on the driver's back only in vertical direction, on different tracks. In the Figure 9, there are results of all the tractors in this experiment. They form, on each track, an area marked in the Figure.

In Figure 10, there are expressed the RMS-values of the often appearing effective acceleration amplitudes of some forest tractors, in vertical and lateral directions at the mounting point of the seat, and in vertical direction on the driver's back when tested on the track of the Institute. Graphs a, b, and c/10 represent the results obtained from Valmet BK—LM at

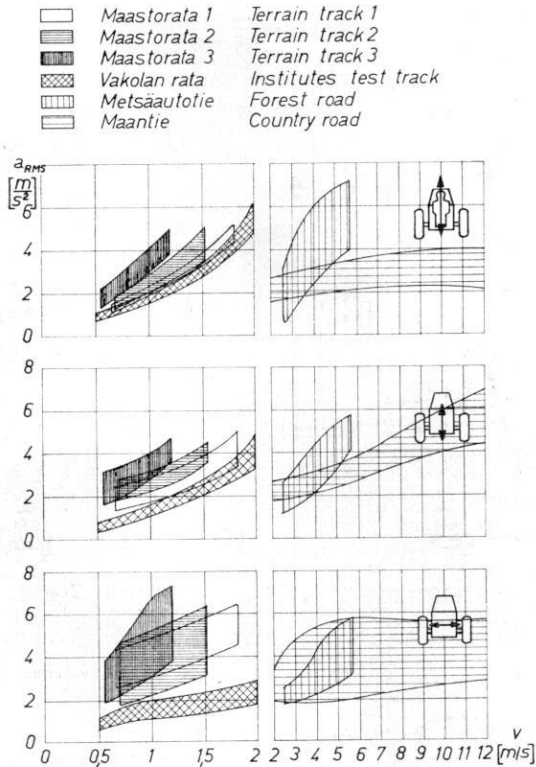

Figure 9. The RMS-value of the effective vertical and lateral acceleration amplitude measured at the mounting point of the seat of the tractors within the experiment, and on the operator's back in vertical direction, on different tracks.

different velocities. In graphs d, e, f, and g/10 the results represent such a running speed for different tractors where the vibration on the driver's back does not exceed the 2.5 hours' »Exposure Limit».

In Figure 11, you can see the most serious vertical rocking as function of the velocity. The rocking, which applies to the operator on different test tracks, is defined in third octave band analysis. The most disadvantageous one of the acceleration values, at different frequency bands, has been obtained by multiplying the analysed results by the weighting factors based on the human tolerance according to ISO/TC 108/WG 7 N 36.

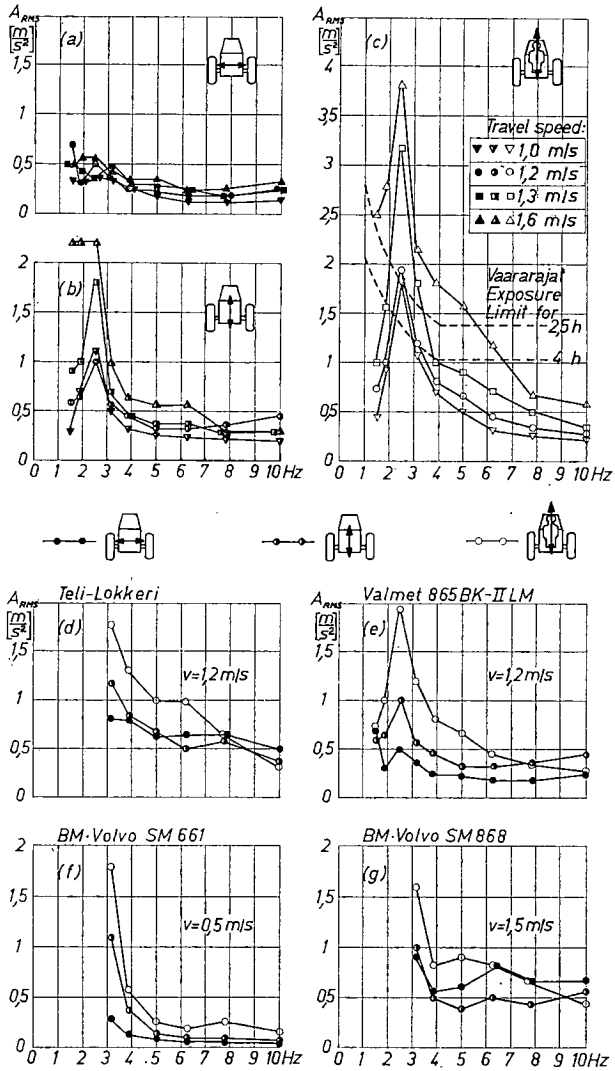

Figure 10. The RMS-values of the often appearing effective acceleration amplitudes, in vertical and lateral directions at the mounting point of the seat, and in vertical direction on the operator's back when tested on the track of the Institute. Graphs a, b, and c represent the results obtained from Valmet BK-LM at different velocities. In graphs d, e, f, and g the results represent such a running speed for different tractors where the vibration on the operator's back does not exceed the 2,5 hours' »Exposure Limit».

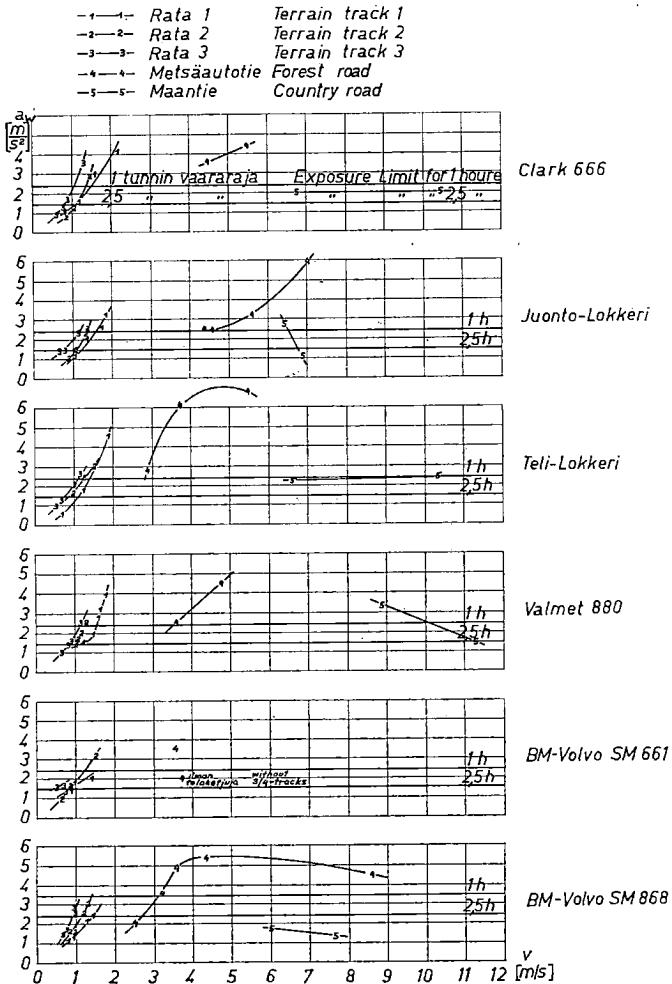

Figure 11. The most serious vertical rocking applying the operator, on different test tracks, as a function of the velocity. The most disadvantageous one—as to the human tolerance—of the results in the third octave band analysis.

On the basis of the Figure 11, Table 3 has been prepared. There you can find the highest allowed speed limited by the vertical rocking of the driver, on different test tracks when the daily driving times is 1 or 2,5 hours. The limitation is based on the ISO/TC 108/WG 7 N 36's »Exposure Limit».

Table 3. Highest allowed velocity limited by the vertical vibration of the driver, on different tracks, when the daily driving time is 1 or 2.5 hours: The limitation has been set on the basis of the ISO/TC 108/WG 7 N 36's »Exposure Limit».

Tractor	Terrain track 1	Terrain track 2	Terrain track 3	Forest road ¹⁾	VAKOLA's track
	Velocity (m/s) (1 h a day/2,5 h a day)				
Valmet 880	1.55/1.1	1.25/1.0	1.15/0.8	3.5	1.3/1.15 ²⁾
Clark 666	1.65/1.15	1.4/1.15	1.1/0.85	4.0	—
Juonto-Lokkeri.	1.65/1.1	1.35/1.1	1.2/0.7	4.5	—
BM-Volvo SM 868	1.5/0.95	1.2/0.8	0.95/0.65	2.75	1.7/1.4 ³⁾
BM-Volvo SM 661	1.5/0.7	1.25/0.7	1.0/0.5	3.2	0.9/0.4
Teli-Lokkeri ...	1.45/1.05	1.3/0.85	1.2/0.7	2.9	1.5/1.0
Average	1.55/1.0	1.3/0.9	1.1/0.7	3.55	1.35/1.0
Ranges of variation	$\pm 0.1 / +0.15$ -0.3	$\pm 0.1 / +0.22$ -0.23	$+0.1 / +0.15$ $-0.15 / -0.20$	$+0.95 \dots 0.80$	$+0.35 / +0.4$ $-0.45 / -0.6$

¹⁾ On the forest road there are only results that correspond one hour or shorter daily driving times.

²⁾ Valmet BK—LM -forewarder.

³⁾ Improved seat.

7. Conclusion

During the terrain measurements, there appeared so much electric disturbance in the functioning of the acceleration transducers, which were attached to the mounting point of the seat, that no frequency analysis was able to be made. Instead the total rocking of the tractor in vertical and lateral directions, on different tracks could be cleared up (Fig. 9).

The driver's exposure to the vibration has been measured with an acceleration pickup attached to the back of the driver instead of it being between the seat cushion and the operator, as the I.S.O. working group states. This affects the results to some extent, especially when the rocking is very intensive. Closer to the 1 or 2.5 hour »Exposure Limit», and the rocking being already minor, the differences are rather insignificant.

7.1. The Character of the Vibration on Different Tracks

When the terrain gets more difficult the dynamic character of the rocking decreases. The move of the tractor and the driver are fairly

large, but of any actual forced vibration caused by terrain, cannot be talked. Vibration is mainly natural vibration of the tractor due to bumping against obstacles. Increasing the speed over 1 m/s soon caused vibration to strengthen too intensive. Because man can tolerate lateral rocking about one third worse than vertical rocking (I.S.O. proposal, 1970), the lateral rocking of the operator may in some tractors become more important than the vertical rocking, due to the construction of the tractor and the effect of high obstacles. On the most difficult terrain track one had to drive 17 . . . 37 per cent slower than on the easiest one when rated on the basis of the vertical vibration of the driver.

The greatest danger caused by vibration threatens the driver on fairly good forest roads, where people would most likely speed up over 3 . . . 3.5 m/s. Then vibration is also likely to exceed over the one minute »Exposure Limit». Only when driving at such speeds that seemed very slow, vibration stayd on the level which corresponds about one hour's daily »Exposure Limit». A strong vibration is often due to the fact that the tractor, or the seat, or both of them fall into resonance with the excitation caused by the roughness of the road.

On actual country road the grooving of the surface had not been found to have any very harmful effect because the frequency of the excitation remarkably exceeded the natural frequency of the tractor. Increasing the speed to the maximum velocity usually reduced vibration.

7.2. The Speeds Used and the Tolerable Speeds

In this experiment it was meant to drive first each track at the speed the driver would normally take. After this the speed was both increased and decreased. The speed the drivers first chose, varied fairly much depending on their habits and character. However, it could be distinctly seen that on more difficult tracks the drivers used the speed that corresponded about the 2.5 hour »Exposure Limit». But when the track turned better the velocities increased too much. So on the track # 1, the drivers felt already the speed corresponding the one hour »Exposure Limit», normal. On the forest road even the slowest rides did not go under the one hour »Exposure Limit». The driver is obviously used to think more than of himself, of the danger in letting the load fall, which decreases when the road gets better. On country road when driving unloaded, the only limiting factor, which applies to the driver, is the structural speed of the tractor. Then an intensive rocking is not common. Sometimes even on a country road the tractor may, however, fall into a strong resonance rocking due to the roughness of the road. Such a situation was not observed during the country road measurements.

7.3. Tractor's Structural Effect on Results

Merely by measuring the rocking of the operator one cannot make any conclusions of the effect of the actual construction of the tractor chassis on the rocking because the seat suspensions are for the present so different in their effect. The seats in the experiment as well as the seats of the tractors tested in 1970, on the test track of the Institute, in general, amplify more or less the rocking of the tractor, at least at some low frequencies (Fig. 10).

Placing the seat outside the wheel base increases the rocking in the middle of the wheel base $2(1 + s/a)$ -fold when the obstacle hits under the wheel closest to the seat. In the preceding text s = distance of seat from the closest axle, and a = tractor's wheel base. When the seat is on the wheel base, s is negative. Extending the wheel base up to 5 meters will decrease the swinging of the tractor.

Placing the engine in the front of the tractor will damp swinging.

The tandem axle structure connected with a pendulum type front axle will decrease especially the lateral swinging.

8. Proporsal for a Method of Measuring the Rocking Behavior of a Forest Tractor

8.1. General

A tractor ought to have such mounted equipments that can be considered as normal working machines; such as a timber loader, in rest position, and a winch. Then again no extra weight or extra load is allowed to be used. The tires ought to be a standard size and -capacity for the tractor. The treadbars can be worn up to 35 per cent of their original height, and the tire walls shall not be badly worn. The inflation pressure of the tires shall be within the limits specified by the tire manufacturer for forest work when driven loaded.

8.2. Measuring Procedure

The vertical and lateral vibration is measured at the mounting point of the seat and between the seat and the operator at the rate of

- 1) 3.0 ± 0.2 m/s on a track corresponding forest road
- 2) 1.0 ± 0.1 m/s on a track corresponding forest terrain

The roughness of the tracks is defined in Appendix; Tables 1 and 2, and power spectral densities in Figure 8 and in Figure 1 of the Appendix.

During the measurements the speed is not allowed to be regulated with the breaks.

To measure the vibration an acceleration transducer, an amplifier, and an instrumentation tape recorder are needed. In the system there should be at least four measuring channels so that all four accelerations could be simultaneously measured. The acceleration transducer and the other measuring equipment used shall be described, in a short and clear way, within the presentation of the results. All equipments ought to be calibrated at regular intervals, generally always before measuring. At the frequency range from 1 to 100 Hz, the accuracy on the tape recorder should be better than ± 2 per cent when taking also the faults of the tape speed, which occur during the analysis, into account.

On each track two drivers take turns; one of them weighs about 60 kg, and the other 95 kg. The position and the flexibility of the seat have to be adjusted sufficient for both drivers in accordance with the manufacturer's instructions.

The acceleration of the vibration that appears during the drive shall be recorded, in each test, throughout the whole track. The acceleration transducers will be placed close to the mounting point of the seat and on the cushion. The transducer for the cushion shall be mounted on a 30 cm diameter flat rigid plate, which in turn shall be placed in the middle of the seat cushion underneath the driver. Two test run recordings of each test tractor and seat vibration shall be made. The results are not allowed to differ from each other more than 5 per cent. If greater differences are encountered further repeat runs shall be made to resolve the differences.

8.3. Evaluation of the Results

The recorded measurement results shall be analysed with third octave band filters at the frequency range from 1.0 to 80 Hz; third octave center frequencies being in compliance with the I.S.O. Recommendation R-266. The RMS-value b_r is calculated from each frequency band, by intergrating over the whole test run. The obtained RMS-values shall be compared with the border lines of the ISO/TC 108/WG 7 N 36. The rocking characteristic of the tractor shall be evaluated on the basis of the shortest »Exposure Limit» gained on tracks corresponding both terrain and forest road.

To evaluate the suspension of the seat, the RMS-values of the vertical rocking of both the driver and the tractor at corresponding frequency bands shall be compared with each other. The ratio shall be reported to the nearest 0.05.

The acceleration spectra taken every third octave band, from the seat and the tractor, may be included to the report.

REFERENCES

- AHO, K.: A method for accelerated testing of farm machinery, study rep. Nr. 7 Finnish » Research Institute of Agricultural Engineering, 1969, 16 p.
- »— Från värdering av skakning på skogstraktoren. Tidskrift for Skogbruk 1—1970, 10 p.
- BEKKER, M. G.: Introduction to Terrain-Vehicle Systems, Ann Arbor The University of Michigan Press, 1969, p. 546.
- BJERNINGER, S.: Vibrations of tractor driver. Acta Polytechnica Scandinavica, Mechanic. Eng. Series Nr. 23 1966 122 p.
- BOGDANOFF, J. L. & KOZIN, F.: On the Statistical Analysis of the Motion of Some Simple Two Dimensional Vehicles Moving on a Random Track, U.S. Army Land Locomotion Lab, OTAC. No. LL-66, Warren, Mich. (Ref. BEKKER, M. G. 1969)
- »— & KOZIN, F.: On the Statistical Analysis of Linear Vehicle Dynamics, Proc. First Int. Conf. on Terrain-Vehicle Systems, Edizioni Minerva Tecnica. Torino, 1961. (Ref. BEKKER, M. G. 1969)
- »— & KOZIN, F.: Additional Results on the Statistical Analysis of a Linear Vehicle Using Measured Ground Power Spectral Density, U. S. Army Land Locomotion, ATAC, Rep. No. 8392—LL—96, Warren, Mich., 1963. (Ref. BEKKER M. G. 1969)
- DUPUIS, H.: Senkrechte Schwingbeschleunigungen von Fahrern in Kraftfahrzeugen, auf Ackerschleppern und selbstfahrenden Arbeitsmaschinen. Grundlagen der Landtechnik Nr. 16, 1963 p. 9 . . . 12.
- »— Bewertung der Schwingbeanspruchung bei Fahrern von Ackerschleppern und Landmaschinen im praktischen Einsatz. Landtechnische Forschung Vol. 14, 1964, Nr. 5, p. 145 . . . 149.
- »— BROICHER, H.-A. & PLESZCZYNSKI, W.: Frequenzanalyse mechanischer Schwingungen in drei Richtungen am Schleppersitz. Landtechnische Forschung Vol. 15 1965, Nr. 5, p. 144 . . . 150 and Vol. 16, 1966, Nr. 4, p. 131.
- ISO/TC 108 »Mechanical Vibration and Shock«, Working Group 7 »Mechanical Vibration and Schock Acceptable to Man»: Guide for the evaluation of human exposure to whole-body vibration. Revised Proposal of the Secretariat Nr. 36, 1970.
- LOUDA, L.: Perception and Effect of the Mixture of Two Vertical Sinusoidal Vibrations on Sitting Man. Work Environment—Health, Vol. 7, 1970, p. 62 . . . 66.
- MATHEWS, I. & TALAMO, J. C. D.: Ride comfort for tractor operators. Journal of Agricultural Engineering Research, Vol. 10, 1965 Nr. 2 p. 93 . . . 108.
- MORRISON, C. S. & HARRINGTON, R. E.: Tractor seating for operator comfort. Agric. Engineering Vol. 43, 1962, Nr. 11, p. 632 . . . 635 and 650 . . . 652.
- SCHILLING, E.: Der Einfluss einiger Konstruktionsdaten auf die Aufbaubeschleunigung landwirtschaftlicher Fahrzeuge und die sich daraus ergebene günstige Sitzlage. Grundlagen der Landtechnik Vol. 15, 1965, Nr. 3, p. 81 . . . 86.
- SJØFLOV, L. & DUPUIS, H.: Frequenzspektren der auf den Fahrer einwirkenden mechanischen Schwingungen bei Ackerschleppern und Mähdreschern. Grundlagen der Landtechnik Vol. 18, 1968, Nr. 6, p. 227 . . . 233.

Appendix

Permanent Test Tracks

Each track consists of two parallel strips suitably spaced for the wheel track of the tractor. The surface of each strip may be cast in smoothly surfaced concrete or may be formed of slats of wood or concrete sited firmly in a base framework. The surface of each track strip is defined by the ordinates, of elevation with respect to a level base, listed in Tables 1 and 2. The unevenness of the surface is defined at intervals of 15 or 16 cm along each strip.

The strips shall be firmly sited on level ground. Where the strips are constructed from slats, these shall be 6—8 cm thick, and 15 or 16 cm broad.

The lengths of the tracks are 90 and 70 meters. The power spectral densities of the profiles of different parts along their length are shown in Figure 1, of the Appendix, and as compared to the tracks, in practice, in Figure 8.

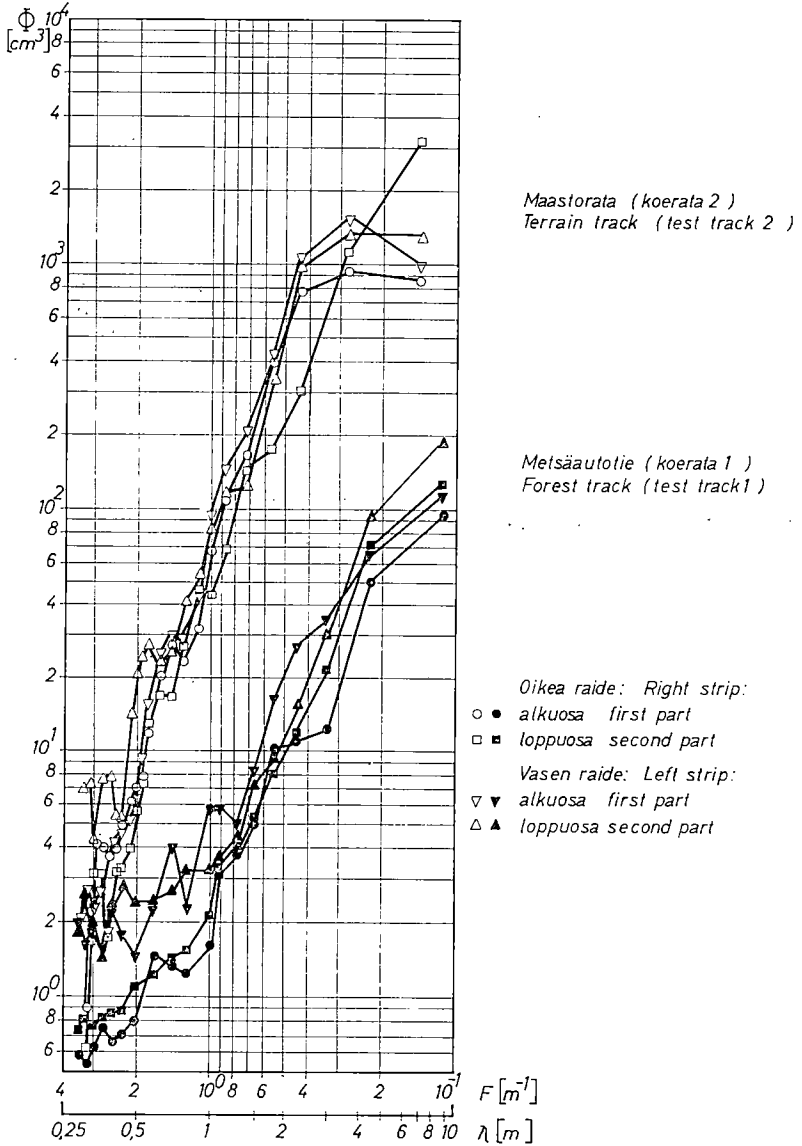

Figure 1. of the Appendix. The power spectral densities of the profiles of the proposed test tracks, at different parts of the tracks.

Table 1. The profile of the track corresponding forest road. Figures (y) correspond the vertical distance of the track from the horizontal level.

x = distance from the start (m)
 y_l = ordinate of left-hand strip (cm)
 y_r = ordinate of right-hand strip (cm)

x	y_l	y_r	x	y_l	y_r	x	y_l	y_r
0,00	1,00	10,0	6,00	11,0	8,5	12,00	10,0	15,0
0,15	10,0	10,0	6,15	11,5	9,0	12,15	7,0	14,5
0,30	9,5	9,5	6,30	11,0	9,0	12,30	9,0	13,5
0,45	9,5	9,5	6,45	11,0	5,0	12,45	9,0	13,0
0,60	9,5	9,5	6,60	12,0	9,0	12,60	9,0	13,0
0,75	9,5	9,0	6,75	13,5	8,5	12,75	9,5	13,0
0,90	9,5	9,5	6,90	14,0	8,5	12,90	8,5	12,0
1,05	10,0	9,5	7,05	14,5	8,5	13,05	9,0	11,5
1,20	10,0	9,0	7,20	14,5	8,0	13,20	9,0	12,0
1,35	9,5	9,0	7,35	14,5	7,5	13,35	9,0	11,0
1,50	9,5	8,5	7,50	14,0	7,0	13,50	10,0	10,0
1,65	9,5	8,0	7,65	13,5	7,0	13,65	9,0	10,0
1,80	8,0	7,5	7,80	12,5	6,5	13,80	10,0	10,0
1,95	8,0	6,5	7,95	12,5	6,5	13,95	10,0	10,0
2,10	7,5	7,0	8,10	12,0	7,5	14,10	10,0	9,0
2,25	7,5	7,0	8,25	11,0	8,0	14,25	8,0	8,5
2,40	8,5	7,0	8,40	8,5	8,0	14,40	9,0	9,5
2,55	8,5	6,5	8,55	6,5	8,5	14,55	9,0	8,0
2,70	9,5	6,0	8,70	9,5	9,0	14,70	9,0	7,5
2,85	9,0	5,5	8,85	10,5	9,0	14,85	8,5	7,5
3,00	10,0	5,0	9,00	11,5	9,5	15,00	7,5	8,0
3,15	10,5	5,5	9,15	10,5	10,5	15,15	9,0	7,5
3,30	11,0	4,0	9,30	10,5	11,0	15,30	6,5	7,5
3,45	11,5	4,5	9,45	10,0	11,0	15,45	5,5	8,0
3,60	10,5	5,5	9,60	10,0	12,0	15,60	7,5	8,0
3,75	9,5	6,0	9,75	9,5	12,5	15,75	7,5	7,0
3,90	9,0	7,0	9,90	10,0	12,0	15,90	6,0	8,0
4,05	9,0	8,0	10,05	10,5	12,5	16,05	6,0	7,5
4,20	9,5	8,0	10,20	11,0	13,0	16,20	5,5	7,5
4,35	9,0	8,0	10,35	11,0	13,5	16,35	4,5	7,5
4,50	10,0	8,0	10,50	11,5	14,5	16,50	6,0	6,0
4,65	11,0	8,0	10,65	11,0	15,0	16,65	6,0	7,5
4,80	12,0	8,0	10,80	12,0	16,0	16,80	6,0	5,0
4,95	12,5	8,0	10,95	12,0	16,0	16,95	6,5	4,5
5,10	12,0	8,5	11,10	11,5	16,0	17,10	6,0	5,0
5,25	12,0	8,0	11,25	12,0	17,0	17,25	6,0	5,0
5,40	11,5	8,0	11,40	11,0	16,5	17,40	6,5	5,5
5,55	11,5	8,5	11,55	10,5	16,5	17,55	7,0	5,0
5,70	11,5	8,5	11,70	10,5	16,5	17,70	6,5	5,0
5,85	11,5	8,5	11,85	10,0	15,5	17,85	6,5	5,0

x	yl	yr	x	yl	yr	x	yl	yr
18,00	7,5	5,0	24,75	12,5	9,5	31,50	9,0	11,0
18,15	7,5	6,0	24,90	12,5	10,0	31,65	9,0	11,0
18,30	7,0	5,0	25,05	13,0	9,5	31,80	9,0	11,0
18,45	8,0	5,5	25,20	14,0	6,5	31,95	9,0	11,5
18,60	9,0	5,5	25,35	14,5	10,0	32,10	8,5	11,5
18,75	9,5	6,0	25,50	13,0	10,0	32,25	10,0	12,0
18,90	10,0	5,5	25,65	13,0	10,5	32,40	9,5	12,0
19,05	10,0	6,0	25,80	12,0	10,5	32,55	10,0	12,0
19,20	11,5	6,0	25,95	11,5	10,0	32,70	10,0	12,5
19,35	11,5	6,0	26,10	11,0	10,0	32,85	10,0	12,0
19,50	11,0	6,0	26,25	10,5	9,5	33,00	10,0	12,5
19,65	11,5	6,5	26,40	10,5	9,5	33,15	10,0	12,0
19,80	10,0	6,5	26,55	8,5	9,5	33,30	9,5	11,5
19,95	12,5	6,0	26,70	10,5	9,5	33,45	10,0	11,0
20,10	9,0	5,0	26,85	10,0	9,0	33,60	9,5	10,5
20,25	9,0	6,0	27,00	9,5	8,5	33,75	9,5	10,0
20,40	12,0	5,0	27,15	9,5	7,5	33,90	9,0	10,0
20,55	13,0	6,0	27,30	9,5	8,5	34,05	9,0	9,5
20,70	13,0	6,0	27,45	10,0	8,5	34,20	10,0	9,5
20,85	12,5	6,0	27,60	10,5	9,5	34,35	9,5	10,0
21,00	11,5	6,0	27,75	10,0	9,5	34,50	9,5	10,0
21,15	11,5	6,0	27,90	10,0	9,0	34,65	9,5	9,5
21,30	10,5	5,0	28,05	9,0	9,5	34,80	9,5	9,5
21,45	7,5	5,5	28,20	9,5	9,5	34,95	9,5	10,5
21,60	8,0	6,5	28,35	10,0	8,0	35,10	9,5	10,5
21,75	10,0	6,0	28,50	10,0	7,0	35,25	11,0	11,0
21,90	10,0	6,0	28,65	9,5	7,5	35,40	11,5	11,5
22,05	11,0	7,0	28,80	9,0	7,5	35,55	12,0	10,5
22,20	10,0	6,5	28,95	9,5	7,0	35,70	12,5	10,5
22,35	11,0	7,5	29,10	9,5	7,0	35,85	12,0	11,5
22,50	11,0	7,5	29,25	9,0	7,0	36,00	12,5	11,0
22,65	12,5	8,0	29,40	9,0	7,5	36,15	12,0	11,0
22,80	12,0	8,0	29,55	10,0	7,0	36,30	8,0	10,5
22,95	10,0	8,0	29,70	10,0	8,5	36,45	6,0	10,5
23,10	11,5	8,5	29,85	10,5	9,0	36,60	9,0	10,5
23,25	9,0	8,5	30,00	10,5	9,0	36,75	9,0	10,0
23,40	8,0	9,0	30,15	10,5	9,5	36,90	9,0	10,5
23,55	9,0	8,5	30,30	10,0	9,5	37,05	8,0	10,5
23,70	9,5	9,0	30,45	10,0	10,0	37,20	7,5	10,5
23,85	9,5	9,0	30,60	9,5	11,0	37,35	7,5	10,0
24,00	10,0	9,5	30,75	9,5	10,0	37,50	7,0	11,0
24,15	10,5	9,0	30,90	8,5	9,0	37,65	8,0	10,5
24,30	10,5	8,5	31,05	8,0	10,5	37,80	8,0	10,5
24,45	11,5	8,5	31,20	8,0	10,5	37,95	8,5	10,5
24,60	11,5	9,5	31,35	8,0	11,0	38,10	9,0	10,5

x	yl	Yr	x	yl	Yr	x	yl	Yr
38,25	9,0	10,0	45,00	11,0	9,5	51,75	5,0	9,0
38,40	6,0	10,0	45,15	11,0	9,0	51,90	5,0	10,5
38,55	8,5	10,0	45,30	10,5	10,5	52,05	5,0	10,5
38,70	6,0	10,5	45,45	10,0	10,0	52,20	4,5	10,0
38,85	11,5	11,0	45,60	10,0	10,5	52,35	4,5	10,0
39,00	8,0	11,5	45,75	10,0	10,5	52,50	4,5	10,0
39,15	6,5	10,5	45,90	10,0	10,0	52,65	5,5	8,0
39,30	5,0	10,0	46,05	10,0	9,0	52,80	5,5	9,0
39,45	5,0	10,5	46,20	9,5	9,0	52,95	5,5	10,0
39,60	4,5	11,0	46,35	9,0	9,5	53,10	5,0	9,5
39,75	5,0	11,5	46,50	8,5	9,0	53,25	5,0	10,0
39,90	4,0	11,0	46,65	8,0	9,5	53,40	4,5	10,0
40,05	5,0	11,0	46,80	7,0	8,5	53,55	4,0	10,0
40,20	5,5	11,5	46,95	6,5	9,0	53,70	3,5	9,5
40,35	6,0	10,5	47,10	7,5	8,5	53,85	3,5	9,5
40,50	6,0	10,5	47,25	7,0	9,0	54,00	1,5	9,0
40,65	6,5	10,5	47,40	6,5	8,0	54,15	3,0	9,5
40,80	6,5	10,5	47,55	5,5	9,0	54,30	3,0	9,5
40,95	7,0	10,0	47,70	5,0	10,0	54,45	3,0	10,0
41,10	7,0	10,0	47,85	4,5	10,5	54,60	3,5	10,0
41,25	8,0	9,5	48,00	4,0	10,0	54,75	3,5	10,0
41,40	9,0	9,5	48,15	3,5	10,0	54,90	5,0	10,0
41,55	9,0	9,5	48,30	3,5	10,5	55,05	5,0	10,0
41,70	9,0	9,5	48,45	3,0	10,0	55,20	5,0	10,0
41,85	8,5	9,5	48,60	2,5	10,5	55,35	4,5	11,0
42,00	9,0	10,0	48,75	2,5	11,0	55,50	4,5	11,5
42,15	8,0	9,5	48,90	2,5	11,5	55,65	4,0	11,0
42,30	8,0	9,0	49,05	2,5	10,5	55,80	4,0	11,5
42,45	7,5	9,5	49,20	2,5	10,0	55,95	3,5	10,5
42,60	8,5	9,0	49,35	2,5	10,5	56,10	4,0	11,0
42,75	8,5	10,5	49,50	2,5	10,5	56,25	3,5	11,5
42,90	9,5	10,0	49,65	3,0	9,0	56,40	4,5	11,5
43,05	9,5	10,0	49,80	3,0	8,5	56,55	4,0	11,5
43,20	9,0	10,0	49,95	3,0	8,0	56,70	4,5	11,5
43,35	8,5	10,0	50,10	2,0	8,0	56,85	4,0	12,0
43,50	9,5	10,0	50,25	3,5	8,0	57,00	4,0	11,5
43,65	10,0	9,5	50,40	4,5	9,0	57,15	4,5	11,0
43,80	10,0	9,0	50,55	5,5	9,0	57,30	3,5	10,5
43,95	10,0	8,5	50,70	6,0	10,0	57,45	4,5	9,5
44,10	10,0	8,5	50,85	5,0	9,0	57,60	4,5	11,0
44,25	10,5	9,0	51,00	5,5	9,0	57,75	4,5	10,5
44,40	10,5	9,0	51,15	5,0	11,0	57,90	4,0	11,0
44,55	10,0	9,0	51,30	5,5	10,5	58,05	3,5	11,0
44,70	11,0	8,0	51,45	5,5	11,0	58,20	4,5	10,5
44,85	11,0	9,5	51,60	5,5	11,0	58,35	5,0	10,5

x	Y ₁	Y _r	x	Y ₁	Y _r	x	Y ₁	Y _r
58,50	6,0	9,5	65,25	11,0	11,0	72,00	10,5	8,0
58,65	5,5	10,0	65,40	11,0	11,0	72,15	10,5	8,0
58,80	5,5	9,5	65,55	11,0	11,0	72,30	10,5	8,0
58,95	5,5	9,0	65,70	10,5	10,5	72,45	10,5	8,0
59,10	5,5	9,0	65,85	10,5	12,0	72,60	10,5	7,5
59,25	5,5	9,0	66,00	10,5	12,5	72,75	10,5	8,0
59,40	5,5	9,0	66,15	10,5	13,5	72,90	10,5	7,5
59,55	5,0	9,0	66,30	10,5	14,0	73,05	10,5	6,5
59,70	5,0	9,0	66,45	10,5	14,0	73,20	10,5	6,5
59,85	5,0	9,0	66,60	10,0	13,5	73,35	10,5	6,5
60,00	5,5	9,0	66,75	10,5	13,5	73,50	10,5	8,0
60,15	5,5	9,0	66,90	10,5	14,0	73,65	9,5	8,5
60,30	5,5	9,0	67,05	11,5	14,5	73,80	10,0	8,0
60,45	6,0	9,0	67,20	12,0	14,5	73,95	10,0	10,0
60,60	6,0	9,0	67,35	12,0	15,0	74,10	10,0	8,5
60,75	6,5	9,0	67,50	12,5	15,0	74,25	10,0	8,0
60,90	7,0	9,0	67,65	13,5	15,5	74,40	10,5	7,5
61,05	6,5	10,0	67,80	14,0	15,5	74,55	10,5	7,0
61,20	7,0	10,0	67,95	14,0	16,0	74,70	10,0	7,5
61,35	7,5	11,0	68,10	14,0	16,0	74,85	10,0	8,5
61,50	7,5	11,0	68,25	14,0	16,5	75,00	10,5	8,5
61,65	7,5	11,0	68,40	14,0	17,0	75,15	10,5	9,0
61,80	8,0	11,0	68,55	14,0	17,5	75,30	9,5	9,5
61,95	8,5	11,0	68,70	14,0	16,5	75,45	8,5	10,0
62,10	9,0	11,0	68,85	14,0	16,0	75,60	8,5	10,0
62,25	9,0	11,0	69,00	14,0	15,5	75,75	9,0	10,0
62,40	9,5	11,5	69,15	14,0	14,5	75,90	9,5	10,0
62,55	9,5	12,0	69,30	14,5	13,0	76,05	10,0	10,0
62,70	9,5	12,0	69,45	14,5	14,0	76,20	10,0	10,0
62,85	10,0	13,0	69,60	14,0	13,0	76,35	10,0	9,5
63,00	10,5	13,0	69,75	14,0	13,0	76,50	10,5	9,0
63,15	10,5	11,0	69,90	14,0	11,0	76,65	10,5	9,5
63,30	11,0	11,0	70,05	13,5	11,5	76,80	11,0	9,5
63,45	11,5	10,0	70,20	13,0	11,0	76,95	10,0	9,0
63,60	11,5	10,0	70,35	12,0	11,0	77,10	10,5	9,0
63,75	11,5	11,0	70,50	12,0	11,0	77,25	11,0	9,5
63,90	12,0	10,5	70,65	11,5	10,5	77,40	11,0	9,0
64,05	12,0	11,0	70,80	11,0	10,5	77,55	10,0	9,5
64,20	12,0	11,0	70,95	10,0	10,0	77,70	10,5	10,5
64,35	12,0	11,0	71,10	10,0	9,5	77,85	9,5	11,0
64,50	11,5	11,0	71,25	10,0	9,0	78,00	9,5	11,5
64,65	11,5	11,0	71,40	10,5	9,0	78,15	10,0	12,0
64,80	11,0	11,0	71,55	10,5	9,0	78,30	10,0	12,5
64,95	11,0	11,0	71,70	10,0	8,5	78,45	10,0	12,5
65,10	11,0	11,0	71,85	10,5	8,5	78,60	9,0	12,5

x	yl	Yr	x	yl	Yr	x	yl	Yr
78,75	8,5	12,5	82,50	9,5	12,5	86,25	12,0	9,5
78,90	9,0	12,0	82,65	9,5	12,5	86,40	12,5	10,0
79,05	8,5	12,0	82,80	9,0	13,0	86,55	12,0	10,0
79,20	8,0	12,0	82,95	9,0	13,0	86,70	11,5	11,0
79,35	8,0	11,0	83,10	9,0	13,0	86,85	12,0	11,0
79,50	8,0	10,0	83,25	9,5	13,0	87,00	12,0	11,5
79,65	8,0	10,0	83,40	9,5	13,0	87,15	12,0	11,0
79,80	8,5	10,0	83,55	10,0	12,5	87,30	11,5	11,0
79,95	8,5	10,5	83,70	10,0	11,5	87,45	12,0	11,0
80,10	8,5	10,5	83,85	10,5	11,5	87,60	12,5	11,0
80,25	8,5	11,0	84,00	10,5	11,0	87,75	12,5	11,0
80,40	8,5	11,0	84,15	11,0	11,0	87,90	12,5	10,0
80,55	8,5	11,0	84,30	11,5	11,0	88,05	12,0	10,0
80,70	9,0	11,0	84,45	11,0	11,0	88,20	11,5	10,0
80,85	9,0	11,0	84,60	9,5	11,0	88,35	11,5	9,0
81,00	9,0	11,0	84,75	10,0	11,0	88,50	11,5	9,0
81,15	9,5	10,5	84,90	11,0	11,0	88,65	11,5	9,0
81,30	9,5	10,5	85,05	11,0	10,5	88,80	10,0	8,5
81,45	9,5	9,5	85,20	11,5	10,5	88,95	10,5	8,0
81,60	9,5	10,0	85,35	11,5	11,0	89,10	10,0	7,5
81,75	9,5	10,5	85,50	11,5	11,0	89,25	10,0	7,5
81,90	9,0	11,0	85,65	11,5	9,5	89,40	8,5	7,0
82,05	9,0	11,5	85,80	12,0	9,5	89,55	9,0	6,0
82,20	9,5	12,0	85,95	11,5	8,0	89,70	8,0	6,0
82,35	9,5	12,0	86,10	12,0	8,5	89,85	8,0	5,0
						90,00	8,0	5,0

Table 2. The profile of the track corresponding forest terrain. Figures (y) correspond the vertical distance of the track from the horizontal level.

x = distance from the start (m)

y_l = ordinate of left-hand strip (cm)y_r = ordinate of right-hand strip (cm)

x	y _l	y _r	x	y _l	y _r	x	y _l	y _r
0,00	12,0	7,5	6,40	16,5	8,5	12,80	14,0	4,5
0,16	11,5	12,0	6,56	12,5	9,0	12,96	12,0	7,5
0,32	13,0	15,0	6,72	13,5	5,5	13,12	5,0	11,0
0,48	9,0	17,5	6,88	14,0	2,0	13,28	2,5	15,0
0,64	5,5	17,0	7,04	12,0	2,0	13,44	2,0	20,0
0,80	5,0	17,5	7,20	7,5	3,5	13,60	1,5	22,0
0,96	6,0	15,0	7,36	9,0	5,0	13,76	1,0	18,0
1,12	6,5	10,0	7,52	12,5	7,5	13,92	1,0	14,0
1,28	5,0	8,0	7,68	11,5	8,5	14,08	0,5	8,0
1,44	3,5	7,5	7,84	6,0	8,5	14,24	3,0	3,0
1,60	3,5	6,5	8,00	5,0	6,5	14,40	6,5	1,5
1,76	4,0	5,0	8,16	5,0	8,0	14,56	8,0	0,0
1,92	15,0	6,5	8,32	5,5	8,0	14,72	9,5	0,0
2,08	22,5	10,0	8,48	6,0	12,0	14,88	12,5	1,0
2,24	22,0	21,0	8,64	11,5	13,5	15,04	12,5	2,0
2,40	21,5	22,0	8,80	18,0	13,5	15,20	11,5	2,5
2,56	22,0	22,0	8,96	22,0	11,0	15,36	10,0	5,0
2,72	21,5	22,0	9,12	20,0	7,0	15,62	7,0	12,0
2,88	22,5	22,0	9,28	15,0	5,5	15,68	6,5	12,5
3,04	23,0	22,5	9,44	12,5	5,0	15,84	8,0	11,5
3,20	23,0	24,0	9,60	10,5	5,5	16,00	8,0	12,5
3,36	23,0	22,5	9,76	3,0	5,5	16,16	9,5	14,5
3,52	10,0	21,5	9,92	2,0	7,0	16,32	9,0	15,0
3,68	3,0	22,0	10,08	2,0	4,0	16,48	7,5	15,5
3,84	2,0	5,0	10,24	1,5	4,5	16,64	7,0	15,0
4,00	3,0	2,0	10,40	2,0	2,5	16,80	6,5	14,5
4,16	4,0	1,0	10,56	2,5	0,0	16,96	5,0	13,0
4,32	3,5	1,0	10,72	1,5	0,0	17,12	7,5	14,5
4,48	3,5	0,5	10,88	2,0	0,0	17,28	14,0	14,5
4,64	4,5	0,0	11,04	2,0	0,5	17,44	19,0	13,5
4,80	3,0	1,0	11,20	4,0	1,0	17,60	19,5	12,5
4,96	2,0	1,0	11,36	2,0	1,0	17,76	19,5	12,0
5,12	4,0	2,0	11,52	2,0	2,0	17,92	19,0	11,5
5,28	7,0	4,0	11,68	1,5	4,0	18,08	19,0	7,0
5,44	13,0	6,5	11,84	2,0	6,0	18,24	19,5	5,0
5,60	17,0	10,0	12,00	3,5	5,5	18,40	19,5	0,0
5,76	21,0	11,0	12,16	7,0	4,0	18,56	19,5	0,0
5,92	24,0	7,5	12,32	12,0	1,5	18,72	18,5	0,0
6,08	23,5	5,0	12,48	14,5	1,5	18,88	18,5	0,0
6,24	19,0	5,5	12,64	15,0	2,5	19,04	12,5	2,5

x	Yl	Yr	x	Yl	Yr	x	Yl	Yr
19,20	3,5	3,5	26,40	18,5	4,5	33,60	16,5	10,5
19,36	2,0	4,5	25,56	19,5	4,5	33,76	17,0	15,0
19,52	4,0	6,5	26,72	20,5	3,0	33,92	18,5	14,0
19,68	5,0	8,0	26,88	22,0	2,0	34,08	18,0	15,0
19,84	6,5	10,5	27,04	20,5	1,5	34,24	14,0	14,5
20,00	5,0	7,0	27,20	19,0	2,0	34,40	13,0	14,5
20,16	7,0	6,0	27,36	13,0	4,0	34,56	14,0	12,5
20,32	7,5	6,0	27,52	9,0	7,5	34,72	17,0	10,0
20,48	8,0	6,0	27,68	7,0	10,5	34,88	17,5	11,0
20,64	10,5	6,0	27,84	7,5	8,0	35,04	18,0	17,0
20,80	13,0	6,5	28,00	9,5	8,5	35,20	15,0	17,5
20,96	12,0	9,0	28,16	11,5	10,0	35,36	12,5	18,0
21,12	6,0	12,0	28,32	9,0	12,0	35,52	12,0	19,0
21,28	1,0	10,0	28,48	0,5	11,0	35,68	11,5	10,0
21,44	1,5	6,0	28,64	3,0	10,5	35,84	10,0	18,0
21,60	1,0	9,5	28,80	4,0	5,5	36,00	9,5	17,5
21,76	0,5	15,0	28,96	4,5	3,0	36,16	10,0	17,0
21,92	3,0	18,0	29,12	5,0	2,0	36,32	11,5	16,0
22,08	6,0	16,0	29,28	10,0	1,0	36,48	12,0	16,0
22,24	7,5	15,0	29,44	15,0	0,0	36,64	14,0	18,0
22,40	14,0	12,5	29,60	20,0	0,0	36,80	19,5	28,0
22,56	20,0	3,5	29,76	23,0	2,0	36,96	19,0	31,0
22,72	29,0	2,0	29,92	21,5	2,0	37,12	16,5	31,0
22,88	26,5	0,0	30,08	14,0	4,0	37,28	13,5	31,0
23,04	22,0	1,0	30,24	7,5	6,5	37,44	14,5	30,5
23,20	20,0	7,5	30,40	7,0	8,0	37,60	13,5	30,5
23,36	16,0	14,0	30,56	10,0	11,0	37,76	7,0	30,5
23,52	14,5	18,5	30,72	9,5	12,5	37,92	7,5	31,0
23,68	14,0	17,5	30,88	7,0	13,0	38,08	10,0	31,0
23,84	11,0	14,0	31,04	6,5	13,0	38,24	10,0	31,0
24,00	7,5	10,0	31,20	8,0	12,0	38,40	12,0	31,0
24,16	12,0	6,0	31,36	8,5	7,0	38,56	12,5	31,5
24,32	11,0	5,0	31,52	9,0	2,5	38,72	15,5	29,0
24,48	9,0	4,0	31,68	13,0	1,5	38,88	17,0	20,0
24,64	8,5	2,5	31,84	16,0	3,0	39,04	20,0	10,0
24,80	10,0	2,5	32,00	14,5	10,0	39,20	22,0	7,0
24,96	10,0	3,0	32,16	12,0	10,5	39,36	21,5	7,0
25,12	6,0	4,5	32,32	10,5	7,5	39,52	15,0	7,5
25,28	5,0	4,5	32,48	8,5	10,0	39,68	6,0	8,0
25,44	4,5	4,0	32,64	8,0	12,0	39,84	9,5	9,0
25,60	8,0	4,5	32,80	7,5	10,0	40,00	7,5	9,5
25,76	10,5	7,5	32,96	12,0	6,0	40,16	6,5	9,5
25,92	11,5	11,0	33,12	13,0	9,0	40,32	9,0	10,0
26,08	12,5	7,0	33,28	14,0	11,5	40,48	10,0	10,0
26,24	15,5	4,0	33,44	15,0	10,5	40,64	11,5	9,5

x	y _t	y _r	x	y _t	y _r	x	y _t	y _r
40,80	14,0	9,0	48,00	22,0	15,0	55,20	19,5	10,5
40,96	15,5	8,5	48,16	22,5	8,5	55,36	21,5	11,0
41,12	17,0	7,5	48,32	15,0	8,5	55,52	21,0	10,0
41,28	19,0	7,0	48,48	10,0	9,0	55,68	20,5	9,5
41,44	24,0	7,0	48,64	10,0	11,0	55,84	22,0	9,5
41,60	24,5	8,0	48,80	10,5	17,5	56,00	19,0	9,0
41,76	24,5	9,0	48,96	12,5	18,5	56,16	15,5	8,5
41,92	12,0	10,0	49,12	9,5	14,0	56,32	18,0	9,5
42,08	6,0	9,0	49,28	6,0	10,5	56,48	17,5	10,0
42,24	8,0	8,0	49,44	4,5	9,5	56,64	16,0	12,0
42,40	10,0	9,0	49,60	5,0	8,0	56,80	17,0	14,0
42,56	10,5	12,0	49,76	8,0	7,5	56,96	16,0	16,0
42,72	11,0	10,0	49,92	9,5	7,5	57,12	14,0	16,5
42,88	12,5	9,0	50,08	13,5	4,0	57,28	15,5	18,0
43,04	16,0	11,0	50,24	13,0	1,5	57,44	17,0	16,0
43,20	24,5	20,0	50,40	16,5	1,0	57,60	18,0	14,5
43,36	25,0	30,0	50,56	24,5	0,0	57,76	19,5	11,0
43,52	25,0	30,5	50,72	24,5	1,0	57,92	20,0	10,5
43,68	25,0	31,0	50,88	21,0	4,0	58,08	20,0	12,5
43,84	25,0	31,0	51,04	19,5	6,0	58,24	21,0	12,5
44,00	25,0	31,0	51,20	10,0	6,0	58,40	16,0	14,0
44,16	25,0	31,0	51,36	4,0	6,5	58,56	16,5	13,0
44,32	24,5	31,5	51,52	3,0	8,0	58,72	14,5	12,5
44,48	24,5	32,0	51,68	7,0	10,0	58,88	13,0	12,0
44,64	24,5	32,0	51,84	7,0	9,5	59,04	14,0	13,0
44,80	25,0	32,0	52,00	4,0	2,5	59,20	15,0	13,0
44,96	10,0	32,0	52,16	0,5	4,0	59,36	15,5	10,0
45,12	12,0	32,0	52,32	1,0	0,0	59,52	14,0	11,5
45,28	12,0	31,5	52,48	2,5	1,0	59,68	10,5	13,5
45,44	10,0	30,0	52,64	5,5	0,0	59,84	9,0	15,0
45,60	9,5	13,0	52,80	6,5	2,0	60,00	6,5	11,0
45,76	12,0	11,5	52,96	9,0	2,5	60,16	9,5	10,0
45,92	14,0	12,5	53,12	12,0	3,5	60,32	9,0	12,0
46,08	11,5	12,0	53,28	16,5	5,0	60,48	8,0	10,5
46,24	12,0	12,5	53,44	22,0	7,0	60,64	9,0	9,5
46,40	16,0	13,0	53,60	26,0	10,0	60,80	8,0	9,0
46,56	17,0	12,5	53,76	29,0	11,5	60,96	18,0	9,5
46,72	19,0	11,0	53,92	30,5	12,5	61,12	22,0	10,5
46,88	20,0	11,0	54,08	32,5	12,5	61,28	21,0	9,0
47,04	19,5	13,0	54,24	34,5	10,0	61,44	15,0	7,0
47,20	12,0	16,5	54,40	32,5	8,5	61,60	20,5	5,5
47,36	13,0	16,5	54,56	22,0	9,0	61,76	17,5	6,0
47,52	18,0	16,0	54,72	18,0	8,5	61,92	16,5	7,0
47,68	20,0	16,5	54,88	17,5	10,5	62,08	17,5	6,5
47,84	20,5	17,0	55,04	17,5	11,5	62,24	15,0	5,0

x	y _l	y _r	x	y _l	y _r	x	y _l	y _r
62,40	8,0	3,0	65,60	18,0	3,5	68,80	1,0	3,0
62,56	7,5	3,5	65,76	18,0	4,5	68,96	3,0	3,0
62,72	5,0	4,0	65,92	19,5	5,5	69,12	5,0	5,0
62,88	3,5	4,5	66,08	19,5	4,0	69,28	4,0	5,5
63,04	5,0	3,5	66,24	19,0	3,0	69,44	2,5	5,0
63,20	8,5	3,5	66,40	18,0	5,0	69,60	6,0	5,5
63,36	9,0	3,0	66,56	18,5	10,0	69,76	8,0	4,5
63,52	12,5	3,5	66,72	19,0	12,0	69,92	6,5	6,0
63,68	16,0	3,5	66,88	18,0	11,5	70,08	3,5	7,0
63,84	19,0	3,0	67,04	18,0	12,5			
64,00	19,5	4,0	67,20	12,0	11,5			
64,16	19,0	3,0	67,36	5,0	11,5			
64,32	19,5	3,0	67,52	5,0	11,5			
64,48	19,0	3,5	67,68	5,5	11,5			
64,64	15,0	5,5	67,84	4,0	11,0			
64,80	9,0	5,0	68,00	4,0	11,5			
64,96	6,5	4,5	68,16	3,5	12,0			
65,12	5,5	5,5	68,32	2,0	11,5			
65,28	5,0	7,0	68,48	2,0	9,5			
65,44	9,0	5,0	68,64	1,0	2,5			

Helsinki 1971. Valtion painatuskeskus